

RDP180

INSTALLATION & OPERATION MANUAL

RDP180

INSTALLATION AND OPERATION MANUAL

© Open Control Solutions, Inc.
605 N. John Rodes Blvd., Melbourne, FL 32934
Phone 321-435-5010 • Fax 321-259-4006

NOTICE

Open Control Solutions, Inc. assumes no responsibility for any errors that may appear in this document, nor does it make any commitment to update the information contained herein. However, questions regarding the information contained in this document are welcomed.

Open Control Solutions, Inc. also reserves the right to make changes to the specifications of the RDP180 RAIL Data Processor and to the information contained in this document at any time without notice.

DFS-00510-008-01

This document last revised: May 30, 2017

TABLE OF CONTENTS

PREFACE	1
Purpose of this Manual.....	1
Document Conventions.....	1
Organization.....	1
Definition of Terms.....	2
CHAPTER 1: PRODUCT OVERVIEW.....	3
Description	3
Technical Specifications	4
General Specifications	4
Onboard I/O	4
Digital Inputs	4
Digital Outputs	4
Analog Inputs	4
RS-232 DCE Interface (COM1)	5
RS-485 Interface (COM1)	5
RS-232 DTE Interface (COM2).....	5
Ethernet Interface.....	6
Modem.....	6
LEDs	6
RDP180 Dimensions	7
RDP180 Interface.....	8
Reserved Set Point Registers	8
Special Function Registers.....	9
Connector Pinouts	10
Power	10
RS-232 DCE Com Port (COM1)	10
RS-485 Interface (COM1)	11
RS-232 DTE Com Port (COM2)	11
Onboard I/O.....	11
CHAPTER 2: BEFORE YOU BEGIN	13
Safety Precautions.....	13
General Precautions	13
Working with the RDP180.....	13
Protecting Against Electrostatic Discharge.....	14
Site Selection.....	14
Receipt of Equipment.....	14
CHAPTER 3: PRINCIPLES OF OPERATION.....	15
Overview	15
Serial Ports	16
COM1	16
COM2	16
Ethernet Port	16
Onboard I/O	16
I/O Mapping.....	17
Programmed with Ladder Logic	17
Monitor and Control via Custom Screens	18
Controlled Shutdown	18
Voltage Monitoring.....	18
Autodialer (Optional).....	19

Typical RDP180 Application.....	20
CHAPTER 4: QUICK START GUIDE	21
CHAPTER 5: HARDWARE INSTALLATION	23
Mounting the RDP180.....	23
Power	24
Ethernet Interface.....	24
Modbus Serial Interfaces	25
RS-232 DCE/RS-485 Interface (COM1).....	25
RS-232 DTE Interface (COM2)	26
Serial Cable Wiring Diagrams.....	27
9-Pin to 9-Pin Serial Modem Cable	27
9-Pin to 9-Pin Serial Null Modem Cable	27
9-Pin to 9-Pin Serial 3-Wire Modem Connection	27
9-Pin to 9-Pin Serial 3-Wire Null Modem Connection	28
Onboard I/O	29
Digital Inputs	29
Digital Outputs	30
Analog Input.....	31
Analog Bit Format.....	31
Using the Analog Input as Digital I/O.....	31
4-20mA / 0-20mA Current Loop.....	32
1-5V / 0-5V Voltage Source.....	33
CHAPTER 6: AUTODIALER.....	35
Dial out process	36
Connecting The RDP To A Phone Line	36
Compatible phone systems	36
Phone line connection.....	36
Receiving And Acknowledging An Alarm Call	37
APPENDIX A: TESTING AND TROUBLESHOOTING.....	39
No Communication to RS-232/485 Modbus Devices	39
Connection Refused.....	40
Broadcast RDP IP.....	41
Reset RDP to Factory Default State	42
Controlled Shutdown of Process (Ladder).....	43
Low Battery Voltage	43
Shutdown Button	43
Logic.....	44
APPENDIX B: UPDATE RDP FIRMWARE	45
Firmware Update Procedure.....	45
APPENDIX C: PARTS LIST.....	47
Furnished Parts	47
Optional Parts	47
APPENDIX D: RELEASE NOTES.....	49
APPENDIX E: SUPPORT, SERVICE, AND WARRANTY.....	51
Support and Service	51
Technical Product Assistance	51
Return Authorization (RA) Procedure	51
Warranty Statement	53
Questions or Comments on This Manual	54
INDEX	55

PURPOSE OF THIS MANUAL

This document provides instructions for installing, configuring, programming, testing, and troubleshooting the RAIL Data Processor (RDP180). The RDP180 with optional autodialer function is a compact, DIN-rail mounted, network-enabled PLC that supports the Modbus ASCII, RTU, and TCP protocols. When used in conjunction with an I/O device, such as the RIO128/RIO032, the RDP180 provides distributed process automation.

DOCUMENT CONVENTIONS

The following conventions are used throughout this manual:

- Bulleted lists provide information, not procedural steps.
- Numbered lists provide sequential steps or hierarchical information.
- *Italic* type is used for emphasis

ORGANIZATION

- Chapter 1: Product Overview – describes the functions and uses of the RAIL Data Processor (RDP180) and also provides specifications, including types of interfaces, LED descriptions, and dimensions.
- Chapter 2: Before You Begin – details safety precautions that should be observed when installing and servicing the RDP180, issues to consider when selecting a site, and instructions for receiving equipment.
- Chapter 3: Principles of Operation – Presents information on how the RDP180 operates, including a discussion of serial and network interfaces, I/O mapping, ladder logic, and customized user interfaces.
- Chapter 4: Quick Start Guide– Outlines the steps required when setting up a system.
- Chapter 5: Hardware Installation – Provides instructions for mounting the RDP180 on a DIN-rail, powering the RDP180, and connecting the RDP180 to a transceiver and to a DCE device.
- Chapter 6: Autodialer – Discusses the RDP180's autodialer function, including instructions on connecting the RDP to a phone line, details on the dialout process, and a description of receiving and acknowledging an alarm call.
- Appendix A: Testing and Troubleshooting – Discusses how to test and troubleshoot radio and network communication problems.
- Appendix C: Parts List – Provides a list of products available for use with the RDP180.
- Appendix E: Support, Service, and Warranty – Gives information on how to obtain support and service from Data Flow Systems, Inc. The warranty statement is also provided here.

DEFINITION OF TERMS

The following terms are used throughout this document.

ASCII – A code for representing English characters as numbers, with each letter assigned a number from 0 to 127.

DCE – Data Communications Equipment; a device (e.g., a modem) that provides a path for RS-232 communication and is connected to a DTE device (e.g., a computer).

DFS RTU – Communications protocol developed by Data Flow Systems. This protocol would be used when communicating with DFS equipment through a RIM006.

DTE – Data Terminal Equipment; the terminating end of an RS-232 communications channel. A DTE device (e.g., a computer) controls the flow of data and is connected to a DCE device (e.g., a modem)

Modbus ASCII – A communications protocol developed by Modicon that transmits only ASCII characters and uses ASCII control code to transfer discrete/analog I/O and register data between control devices.

Modbus RTU – A communications protocol developed by Modicon that transmits blocks of data consisting of 8-bit binary characters (with an optional parity bit) between an RTU device and a host computer.

Modbus TCP – A communications protocol developed by Modicon that uses Ethernet and TCP/IP to transfer discrete/analog I/O and register data between control devices.

PPP (Point-to-Point Protocol) – Protocol used over serial lines to support a connection to a TCP/IP network through a modem and a telephone line.

RDP180 – RAIL Data Processor; a compact, DIN-rail mounted, network-enabled PLC that supports the Modbus ASCII, RTU, and TCP protocols. When used in conjunction with an I/O device, such as the RIO128/RIO032, the RDP provides distributed process automation.

RDR200 – RAIL Data Radio; a 2W licensed radio available in 217-220 MHz frequencies that features 1200, 2400, 4800, and 9600 data rates. Asynchronous and DCE protocols. Format is 8 bit characters, E/O/N Parity, 1 or 2 stop bits.

RIO032 – RAIL Input Output (32 I/O points); a DIN-rail mounted I/O device that features 32 I/O points (8 digital inputs, 8 digital outputs, 8 analog inputs, and 8 analog outputs).

RIO128 – RAIL Input Output (128 I/O points); a DIN-rail mounted I/O device that features 128 I/O points (40 digital inputs, 40 digital outputs, 40 analog inputs, and 8 analog outputs).

RNA110 – RAIL Network Adapter; a small-sized, DIN-rail mounted serial-to-network converter.

UART – Component that controls a computer's asynchronous serial communication. The UART interface manages a computer's serial ports. UARTs can also be found in some internal modems.

DESCRIPTION

The RDP180 is a compact, DIN-rail mounted PLC that supports the Modbus ASCII, RTU, and TCP protocols.

Two models are available: RDP180-1 (DFS-00510-008-1) and RDP180-2 (DFS-00510-008-2).

Common Features

- 33 MIP ARM7 Processor
- 8 MB Flash ROM
- 16 MB RAM
- Real Time Clock for Time Functions
- Watch Dog Timer
- Power Source Monitoring
- Onboard I/O (9 digital inputs, 2 digital outputs, 1 analog input)
- 10/100 Mbps Ethernet Connection
- RS-232 DCE/RS-485 Serial Port
- 2 Programmable LEDs
- Configurable I/O-to-Modbus Register Map
- Programmed Using Supplied Ladder Logic Software
- Standard DIN-Rail Mounted Device
- 3 Year Parts & Workmanship Warranty
- SDI-12 interface (future)
- USB interface (future)

RDP180-1 Features

- Voice modem for autodialer function

RDP180-2 Features

- Additional RS-232 serial port (DTE)

TECHNICAL SPECIFICATIONS

GENERAL SPECIFICATIONS

Input power	11.5-14.0 VDC; 250mA
Power up time	16.0 seconds
Temperature range	32° to 140° F (0° to 60° C)
Humidity	Not to exceed 95% (noncondensing)
Dimensions	7.375"W x 5"H x 3"D
Method of programming	PC via network interface
Models	RDP180-1 (ARM7 processor, one serial port, one voice modem) RDP180-2 (ARM7 processor, two serial ports)

ONBOARD I/O

DIGITAL INPUTS

Quantity of digital inputs	9
Input type	Closure-to-ground for on; biased with 10-15 VDC raw power via onboard 5.6 Kohm resistor
On/Off threshold	1.5 VDC
Input current	2.5 mA
Conversion rate	120 samples-per-second with 100 mSec debouncing for on/off status
Modbus Address	Special Function Registers 9900-9908

DIGITAL OUTPUTS

Quantity of digital outputs	2
Output type, configuration	Darlington array sinking to common
Output switch current rating	Current capability to drive 12 or 24 VDC, 80 mA constant duty, 300mA in-rush current, ice-cube type relays
Modbus Address	Special Function Registers 9910 (DO 1) and 9911 (DO 2)

ANALOG INPUTS

Quantity of analog inputs	1
Signal input levels, nominal	0-5V; 4-20mA externally with external 249 ohm .02% resistor
Resolution	12-bit
Maximum ratings	0-5V +/- .2V
Input impedance	511 Kohms
Overload / transient protection	None
Conversion rate	10-samples-per-second
Noise rejection (50/60Hz)	-30dB

Accuracy	Less than 1% error for 0-5V and 4-20mA inputs
Modbus Address	Special Function Register 49923

Note: The analog input can be used as digital I/O by sourcing 0 volts for off and 5 volts for on, and then creating a digital point in the ladder program.

RS-232 DCE INTERFACE (COM1)

Baud rate	≤ 38.4 Kbps
Data bits	8
Parity	Even, Odd, None
Stop bits	1 or 2
Signals	TXD, RXD, RTS, CTS, GND
Protocols	Modbus ASCII and Modbus RTU
Connector	DB-9 female
No. of devices supported	1

Note: COM1 can be used in RS-232 *or* RS-485 mode.

RS-485 INTERFACE (COM1)

Baud rate	≤ 38.4 Kbps
Data bits	8
Parity	Even, Odd, None
Stop bits	1 or 2
Mode	Half-duplex
Protocols	Modbus ASCII and Modbus RTU
Connector	9-pin pluggable screw terminal
No. of devices supported	Up to 16 devices can be daisy-chained on this port

Note: COM1 can be used in RS-232 *or* RS-485 mode.

RS-232 DTE INTERFACE (COM2)

Baud rate	≤ 38.4 Kbps
Data bits	8
Parity	Even, Odd, or None
Stop bits	1 or 2
Signals	TXD, RXD, RTS, CTS, GND
Protocols	Modbus ASCII and Modbus RTU
Connector	DB-9 male
No. of devices supported	1

Note: The interface is for the RDP180-2 only

ETHERNET INTERFACE

Network Data Transfer Rate	10 Mbps Ethernet; 100 Mbps Fast Ethernet
Protocol	Modbus TCP
Connector	RJ-45
LEDs	Link

MODEM

Communication Rate	V.92 Maximum
Connector	RJ-11 Modular (Phone/Telco)
LEDs	TXD, RXD, HOOK

Note: This interface is for the RDP180-1 only

LEDs

LED	Description	Activity
POWER	RDP180 power	<ul style="list-style-type: none"> Off - Power to RDP180 is off On - Power to RDP180 is on and the device is ready
FAULT	CPU failure	
STATUS	RDP180 status	<ul style="list-style-type: none"> On (solid) - Data port is active; RDP/PLC process failed to start 2 sec on/off - Process is running 2 sec on flash, once off – Process has been stopped Rapid flash – RDP/PLC is shutting down 5 sec off flash, once on – RDP/PLC shut down initiated from Shutdown button or PMT/ladder 5 sec off flash, twice on - RDP/PLC shut down due to low voltage (less than 11.2 volts)
ALARM	Alarm status (SFR 9913)*	<ul style="list-style-type: none"> On - Active and unacknowledged alarm exists. (Will not be on for cleared unacknowledged alarms or for active and acknowledged alarms.) Off - No active and unacknowledged alarms exist
RX1	COM1 receive data	Blink - COM1 is receiving data
TX1	COM1 transmit data	Blink - COM1 is transmitting data
RX2	COM2 receive data	Blink - COM2 is receiving data
TX2	COM2 transmit data	Blink - COM2 is transmitting data
RXD	Modem receive data	Blink - Modem (or COM2) is receiving data

TXD	Modem transmit data	Blink - Modem (or COM2) is transmitting data
HOOK	Modem connection (SFR 9912)*	<ul style="list-style-type: none"> On - Autodialer is dialing Off - Autodialer is inactive
LINK	Ethernet connection status	<ul style="list-style-type: none"> Off - No connection on Ethernet On - Ethernet connection established Blink - Ethernet port is sending and receiving data

* See “Special Function Registers” on page 9 for more information.

RDP180 DIMENSIONS

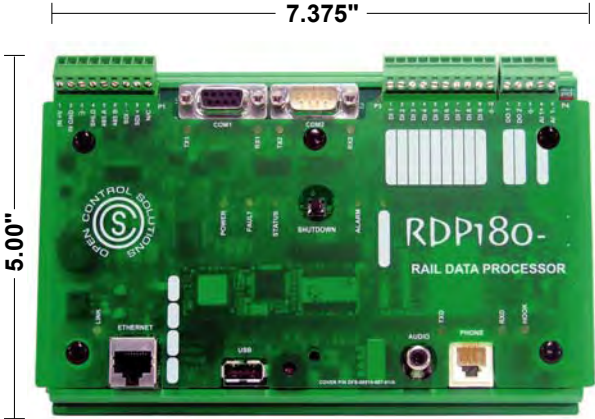

RDP180 INTERFACE

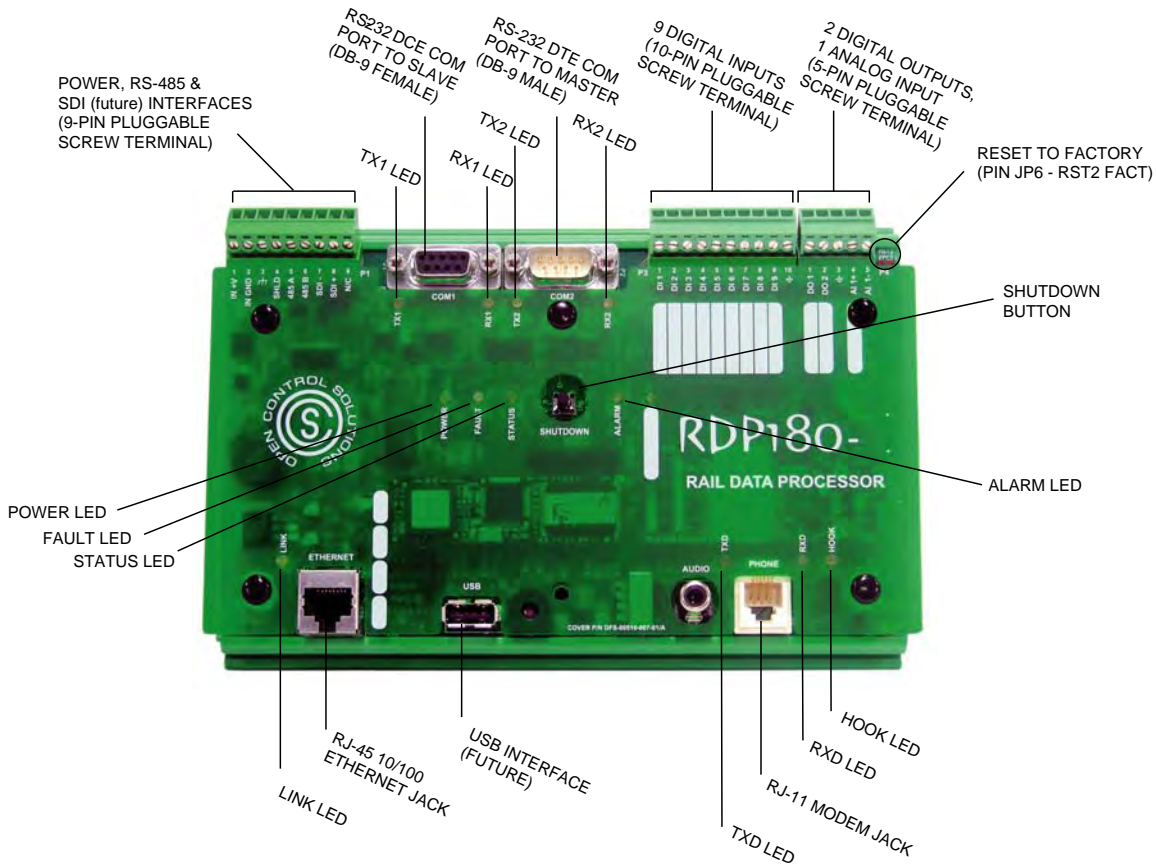

RESERVED SET POINT REGISTERS

Blocks of registers in the DO and AO ranges are reserved for storing user set point values. Values stored in these registers are automatically written (saved) to the RDP’s flash memory every 30 seconds. They are also saved during a controlled shutdown (see “Controlled Shutdown” on the next page).

- During a controlled shutdown, user set point values are written to the RDP’s flash memory. These stored values are loaded when the process resumes.
- In the event of an abrupt loss of power, the process will use the values written to the RDP’s flash memory during the last automated save.

The following registers are reserved for set point values:

- Registers 9800-9899 are reserved in the DO range.
- Registers 49800-49899 are reserved in the AO range.

CONTROLLED SHUTDOWN

The following events initiate a controlled shutdown:

- If voltage in the panel falls below 11.2 volts, the RDP's operating system will initiate the shutdown without user intervention.
- Press the shutdown button on the RDP to manually stop the process. (See page 43.)
- Use Special Function Registers – Process Start Command (9920) and Process Stop Command (9921) – to shutdown the process from a remote location. Special Function Registers are discussed below.

SPECIAL FUNCTION REGISTERS

The following local and derived I/O are provided as special function registers. Most of these registers are for external status queries. For example, registers 9930 (Process Running) and 49902 (Max Ladder Loop Time) give you important information on the status of the RDP. Others, such as 9900 (RDP Input 1) and 9910 (RDP Output 1) can be used in ladders to control the behavior of the RDP.

Note: Registers 9997 and 9998 are used to make sure the RDP and Dataport programs are always running; they are not for use in ladders or at remotes. One program continually updates the register while the other watches it. Should updating stop for 60 seconds after the initial update, the other program will reboot the device.

Table 1-1, Special Function Registers

Address	Function	Ladder R/W	Remote R/W
9900	RDP Input 1	R	R
9901	RDP Input 2	R	R
9902	RDP Input 3	R	R
9903	RDP Input 4	R	R
9904	RDP Input 5	R	R
9905	RDP Input 6	R	R
9906	RDP Input 7	R	R
9907	RDP Input 8	R	R
9908	RDP Input 9	R	R
9910	RDP Output 1	RW	R
9911	RDP Output 2	RW	R
9912	Hook LED	RW	R
9913	Alarm LED	RW	R
9914	User Defined LED	RW	R
9920	Process Start Command	R	RW
9921	Process Stop Command	R	RW
9930	Process Running	RW	R
9940	Global Alarm	R	R
9941	Low Memory Alarm	R	R
9942	Low Voltage Alarm	R	R
9943	RDP I/O Fault Alarm	R	R
9950	RESERVED – DO NOT USE	RW	R
9997	RDP Updates	-	-
9998	Dataport Updates	-	-
49900	Power Supply Voltage	R	R
49901	OS Free Memory	R	R
49902	Max Ladder Loop Time	R	R

Address	Function	Ladder R/W	Remote R/W
49903	Avg Ladder Loop Time	R	R
49904	Min Ladder Loop Time	R	R
49908	Hardware Model	R	R
49909	Hardware Revision	R	R
49910	Software Version Year	R	R
49911	Software Version Month	R	R
49912	Software Version Day	R	R
49913	OS Version Year	R	R
49914	OS Version Month	R	R
49915	OS Version Day	R	R
49916	Serial Number High	R	R
49917	Serial Number Low	R	R
49918	Network Address Octet 4	R	R
49919	Ladder Process ID	RW	R
49920	Ladder Version Year	RW	R
49921	Ladder Version Month	RW	R
49922	Ladder Version Day	RW	R
49923	RDP Analog Input 1	R	R
49950	Comm1 Last Comm	RW	R
49951	Comm2 Last Comm	RW	R
49952	Comm3 Last Comm	RW	R
49953	Comm4 Last Comm	RW	R
49954	Comm5 Last Comm	RW	R
49955	Comm6 Last Comm	RW	R
49999	Remote Reset (data must be 0xA5A5)	R	RW

CONNECTOR PINOUTS

POWER

Pin #	Name	Description
P1-1	IN +V	Incoming power
P1-2	IN GND	Incoming power return
P1-3		Earth ground

RS-232 DCE COM PORT (COM1)

Pin #	Name	Description
J1-1	--	Not connected
J1-2	TX1	COM1 transmit data output
J1-3	RX1	COM1 receive data input
J1-4	--	Not connected
J1-5	COM1GND	COM1 signal ground
J1-6	--	Not connected
J1-7	CTS1	COM1 hardware flow control input
J1-8	RTS1	COM1 hardware flow control output
J1-9	--	Not connected

Note: COM1 can be used in RS-232 *or* RS-485 mode.

RS-485 INTERFACE (COM1)

Pin #	Name	Description
P1-4	485 Shield	RS-485 ground (optional; as required)
P1-5	485 A	RS-485 serial interface A
P1-6	485 B	RS-485 serial interface B



Note: COM1 can be used in RS-485 *or* RS-232 mode.

RS-232 DTE COM PORT (COM2)

Pin #	Name	Description
P2-1	--	Not connected
P2-2	RX2	COM2 Receive data input
P2-3	TX2	COM2 Transmit data output
P2-4	--	Not connected
P2-5	COM2GND	COM2 signal ground
P2-6	--	Not connected
P2-7	RTS2	COM2 hardware flow control output
P2-8	CTS2	COM2 hardware flow control input
P2-9	--	Not connected

Note: This interface is for the RDP180-2 only

ONBOARD I/O

Pin #	Name	Description
P3-1	DI 1	Digital Input 1
:	:	:
P3-9	DI 9	Digital Input 9
P3-10		Ground
P4-1	DO 2	Digital Output 2
P4-2	DO 1	Digital Output 1
P4-3		Ground
P4-4	AI 1-	Analog Input 1 Return
P4-5	AI 1+	Analog Input 1

Notes

Chapter 2: BEFORE YOU BEGIN

SAFETY PRECAUTIONS

Review the following statements before installing, servicing, or replacing the RDP180 or any of its components.

GENERAL PRECAUTIONS

Only trained and qualified personnel should install, service, or replace this equipment.

Carefully read the installation and wiring instructions before installing the RDP180 and connecting it to a power source.

Do not work on the RDP180, or connect or disconnect any of its cables, during periods of lightning activity.

The RDP180 is not designed for use with “high reliability” devices used in industries such as aerospace, nuclear power, and health care.

Do not use the RDP180 in an environment with any of the following conditions:

- Extreme cold or heat [recommended temperature range is 14° to 140° F (-10° to 60° C)]
- High humidity [recommended relative humidity not to exceed 95% (noncondensing)]
- Severe vibration
- Excessive amount of oil present
- Caustic or combustible gas
- Excessive electrical noise

WORKING WITH THE RDP180

When disconnecting a cable, pull on its connector or on its strain-relief loop, not on the cable itself. Some cables have a connector with locking tabs; when disconnecting this type of cable, press in on the locking tabs before disconnecting the cable. When pulling connectors apart, keep them evenly aligned to avoid bending any connector pins. Also, before connecting a cable, make sure both connectors are correctly oriented and aligned.

Insert coaxial cable contact assemblies straight into the plug body without rotation. Do not sharply bend, or crush or flatten, coaxial cable; the cable’s shape affects its performance. Damage introduces reflections in the signal and reduces the efficiency of the cable.

PROTECTING AGAINST ELECTROSTATIC DISCHARGE

Static electricity can harm delicate, static-sensitive components inside the RDP180. To prevent static damage, observe proper ESD procedures during installation, such as putting on an electrostatic discharge wrist strap before touching any of the RDP180's electronic components. Additionally, the following steps can be taken to prevent damage from electrostatic discharge (ESD):

- When unpacking a static-sensitive component from its shipping carton, do not remove the component's antistatic packing material until ready to install the component. Be sure to put on an electrostatic discharge wrist strap before unwrapping the antistatic packaging.
- When transporting a sensitive component, first place it in an antistatic container or packaging.
- Handle all sensitive components in a static-safe area. Place the equipment on a grounded surface. If possible, use antistatic floor pads and workbench pads.

Note: Contact OCS if electrostatic discharge packaging is needed for return shipments. See Return Authorization (RA) Procedure, p. 51 for more information on returning equipment.

SITE SELECTION

When selecting a site for the RDP180, keep the following in mind. The RDP180...

- requires a 12 VDC power source that is capable of providing 350mA, 4 watts of continuous current.
- is designed to operate at the recommended temperature range of 14° to 140° F (-10° to 60° C).
- is designed to operate in an environment with a relative humidity not to exceed 95% (noncondensing).
- should not be use in an environment that experiences severe vibration.
- should not be used in an environment where an excessive amount of oil is present.
- should not be used in an environment where there is caustic or combustible gas.
- should not be used in an environment with excessive electrical noise.
- should not be in close proximity to other RF equipment and/or sensitive RF equipment.
- is designed to be mounted in an industrial control panel with access limited to qualified personnel.
- should be installed in a location that provides easy accessibility for wiring and servicing.

RECEIPT OF EQUIPMENT

When equipment is received, examine the outside of the carton for any damage incurred during shipment. Remove the packing list and the equipment from the shipping carton. Carefully inspect the equipment for damage. Resolve any damage with the local carrier. Report damages to Open Control Solutions (321-435-5010). Include the serial number of the unit and the extent of damage in your report.

Chapter 3: PRINCIPLES OF OPERATION

OVERVIEW

The RDP180 is a compact, DIN-rail mounted, network-enabled PLC that supports the Modbus ASCII, RTU, and TCP protocols. When used in conjunction with a Modbus-compatible I/O device, such as the RIO128 or RIO032, the RDP provides distributed process automation.

The RDP180, powered by a 33 MIP ARM7 processor, features 8MB of Flash ROM, 16MB of RAM, and a real time clock that supports time of day functions. When used with a backup battery, it monitors its own power source and saves accumulated data upon a power failure.

There are two models available:

- RDP180-1 (shown below) features one serial port for interfacing with Modbus devices and a voice modem for autodialer functionality.
- RDP180-2 features two serial ports for interfacing with Modbus devices; there is no modem on this model.

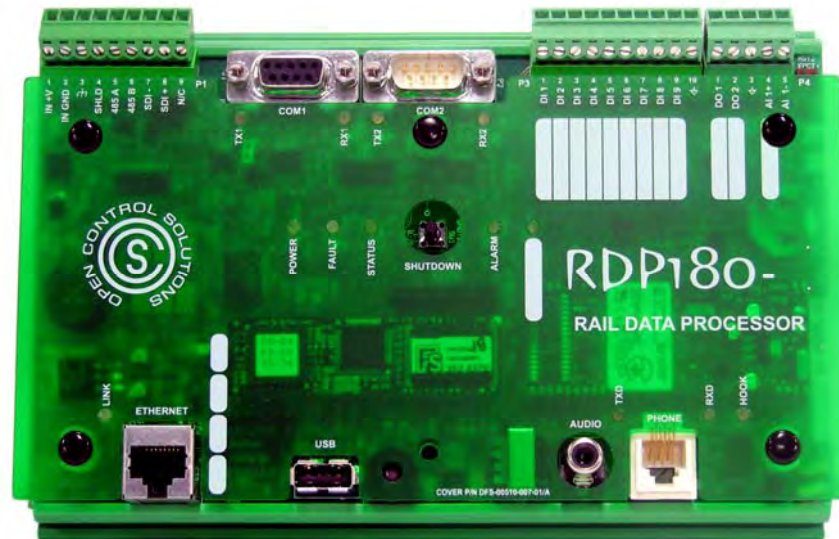

Figure 3-1, RDP180-1

The RDP180 is one component of the RAIL system, a family of DIN-rail mounted products designed specifically for the purpose of remote control and acquisition. The RAIL (Remote Acquisition – Integrated Logic) system features a highly-integrated, modular design with a large point count. All RAIL system components are DIN-rail mounted and may be used alone or integrated with other components of the system.

SERIAL PORTS

The RDP180's serial communication ports are designed for interfacing with Modbus-compatible master and slave serial devices. The RDP180 can use Modbus ASCII or RTU protocol to communicate with these devices at speeds up to 38.4 Kbps.

COM1

COM1 is a DCE port designed to communicate with Modbus-compatible (DTE) slave devices, such as I/O or slave PLC devices. The COM1 serial port can be used in either RS-232 or RS-485 mode. When used in RS-232 mode, COM1 can be connected to a DTE device using a straight cable (or to a DCE device using a null modem cable). When used in RS-485 mode, up to 16 devices can be daisy-chained together. Note that although COM1 is designed to communicate with slave devices, it can also be used as an interface to a Modbus-compatible master device.

COM2

COM2 is an RS-232 DTE port available on the RDP180-2; on the RDP180-1, this port is used internally for the voice modem. COM2 is an RS-232 DTE serial port designed as an interface to a Modbus-compatible (DCE) master device, such as a radio. COM2 can be connected to a DCE device using a straight cable (or to a DTE device using a null modem cable). Note that although COM2 is designed to communicate with master devices, it can also be used as an interface to a Modbus-compatible slave device.

ETHERNET PORT

The RDP180 incorporates one 10/100 Mbps Ethernet interface. This Ethernet interface enables the RDP180 to communicate with Modbus TCP master or slave devices over a 10/100 network. This port is also the RDP180's interface to the Process Management Toolkit (PMT), a suite of applications used to configure, program, and test the RDP180.

When communicating with master devices over the network interface, the RDP180 will remap its I/O and internal (virtual) points into appropriate Modbus registers. This map is also user configurable.

The RDP180 must be assigned its own unique network IP address when it is being used as a Modbus TCP slave device. The RDP180 can be accessed via a "closed" network for the purposes of configuring or programming the device on a test bench before installing it on the network. This is accomplished by directly connecting the RDP180 to a laptop or desktop computer using an Ethernet crossover cable.

ONBOARD I/O

The RDP180 features onboard I/O (nine digital inputs, 2 digital outputs, and one analog input) for systems with limited I/O needs. This is particularly useful for small, stand-alone systems that need to get alarm information back to a central site. Note that the analog input can be used as digital I/O by sourcing 0 volts for off and 5 volts for on, and then creating a digital point in the ladder program.

I/O MAPPING

The physical I/O of all Modbus-compatible devices connected to the RDP must be mapped. This ensures that there are no duplicate, or conflicting, addresses. Once mapping is complete, these registers are available for use in ladders and custom screens.

In mapping, each physical I/O point is assigned to a unique register in the RDP's Logical Memory Map. The Logical Memory Map is comprised of four register ranges:

I/O Type	Register Range
Digital Outputs (Coils)	00001-09999
Digital Inputs (Discrete Inputs)	10001-19999
Analog Inputs (Input Registers)	30001-39999
Analog Outputs (Holding Registers)	40001-49999

When doing this type of mapping, you need to be aware of the registers that have been set aside for special functions (for example, controlling the four programmable LEDs) and the registers reserved for set points. A list of these registers can be found in Chapter 1: Product Overview.

PROGRAMMED WITH LADDER LOGIC

The RDP180 is programmed using Logic Builder, a user-friendly application that enables you to construct "ladder logic"-style programs that manage complex control functions. The logic functions created in ladders make logic decisions, process configured points, and compute internal "virtual" configured points.

The results of these graphical programs are logical points and auto controls that are continuously scanned by the system. The speed of the scanning process enables you to have the most up-to-date information, which, in turn, allows you to react to situations quickly and efficiently.

In traditional ladder logic, the values that flow along rungs and branches are strictly logical, 0 or 1. DFS' Logic Builder provides the extra flexibility of allowing rungs and branches to hold numeric values (for example, the results of math operations, such as ADD and MAXIMUM, and inputs from analog points).

After a ladder logic program has been built and installed, its logical points can be used in custom screens (graphical representations of your process control system) that can be used to remotely monitor and control your system.

Ladder logic is included in the Process Management Toolkit (PMT), a suite of applications used to configure, program, and test the RDP180.

MONITOR AND CONTROL VIA CUSTOM SCREENS

Graphical representations of your process control system can be created using the Screen Builder application. Building a screen – using text, images, objects, and animation – and linking the screen's components to real or logical I/O, enable you to get a real-time view of your operation as well as control processes from a remote location.

For example, you can build a screen that shows the flow of a pump or the level in a well, and then use the device's address (register) to link it to the real field hardware. This linking lets you create a virtual picture of how the equipment is operating; the screen mimics the activity of the equipment. It also enables you to control devices from a remote location. For example, a screen with an On/Off button that is linked to a pump motor can be used to start or stop a pump.

CONTROLLED SHUTDOWN

The following events initiate a controlled shutdown:

- If voltage in the panel falls below 11.2 volts, the RDP's operating system will initiate the shutdown without user intervention. (More information provided in the next section, "Voltage Monitoring.")
- Press the shutdown button on the RDP to manually stop the process. (See page 43.)
- Use Special Function Registers – Process Start Command (9920) and Process Stop Command (9921) – to shutdown the process from a remote location. (See "Special Function Registers" on page 9.)

VOLTAGE MONITORING

The RDP180 has an input power rating of 11.5-14.0 VDC. The RDP180 is designed to monitor the backup battery's voltage and shut down if the voltage falls to 11.2 VDC.

Blocks of registers in the DO and AO ranges are reserved for storing user set point values. Values stored in these registers are automatically written (saved) to the RDP's flash memory every 30 seconds. They are also saved during a controlled shutdown (Controlled Shutdown is discussed in the previous section).

When the RDP180 senses that voltage has dropped to 11.2 volts, it sets the Process Stop Command register (SFR 9921) to true. Approximately 1.5 seconds later values for any configured set point registers are saved. The ladder is then given 30 seconds to perform any actions necessary to put the station in a safe state and set the Process Running register (SFR 9930) to false.

When the RDP180 sees that register 9930 is false, it stops running the ladder in preparation for a physical shut down (e.g., power to the RDP180 is turned off). If the 30 second timer expires before the ladder sets register 9930 to false, the RDP180 sets the register itself and stops running the ladder.

When the process stops due to low battery voltage, you have to restart the ladder by powering up the RDP180, since a loss in voltage is likely caused by loss of AC power.

See "Reserved Set Point Registers" on page 8 and "Special Function Registers" (SFRs) on page 9 for more information on the RDP180's reserved registers.

AUTODIALER (OPTIONAL)

An optional onboard voice modem that is available on the RDP180-1 model enables the RDP180 to function as an autodialer and alert personnel of alarm conditions at RDP180-fitted stations. When a station experiences an alarm condition, the autodialer uses its onboard, voice modem to call a series of preconfigured telephone numbers and announce the alarm via prerecorded voice messages. The alarm announcement includes the station number and a description of the alarm (for example, “high well”).

The autodialer uses a code to prevent an unauthorized person from acknowledging alarms. The recipient of a call must enter a four-digit code, using the keys on their touch-tone phone, before any alarms will be announced. The autodialer then announces the first alarm and prompts the recipient to press 1 (one) to acknowledge or press 2 (two) to replay the message. If there are multiple alarms, each will be announced once the preceding alarm has been properly acknowledged.

TYPICAL RDP180 APPLICATION

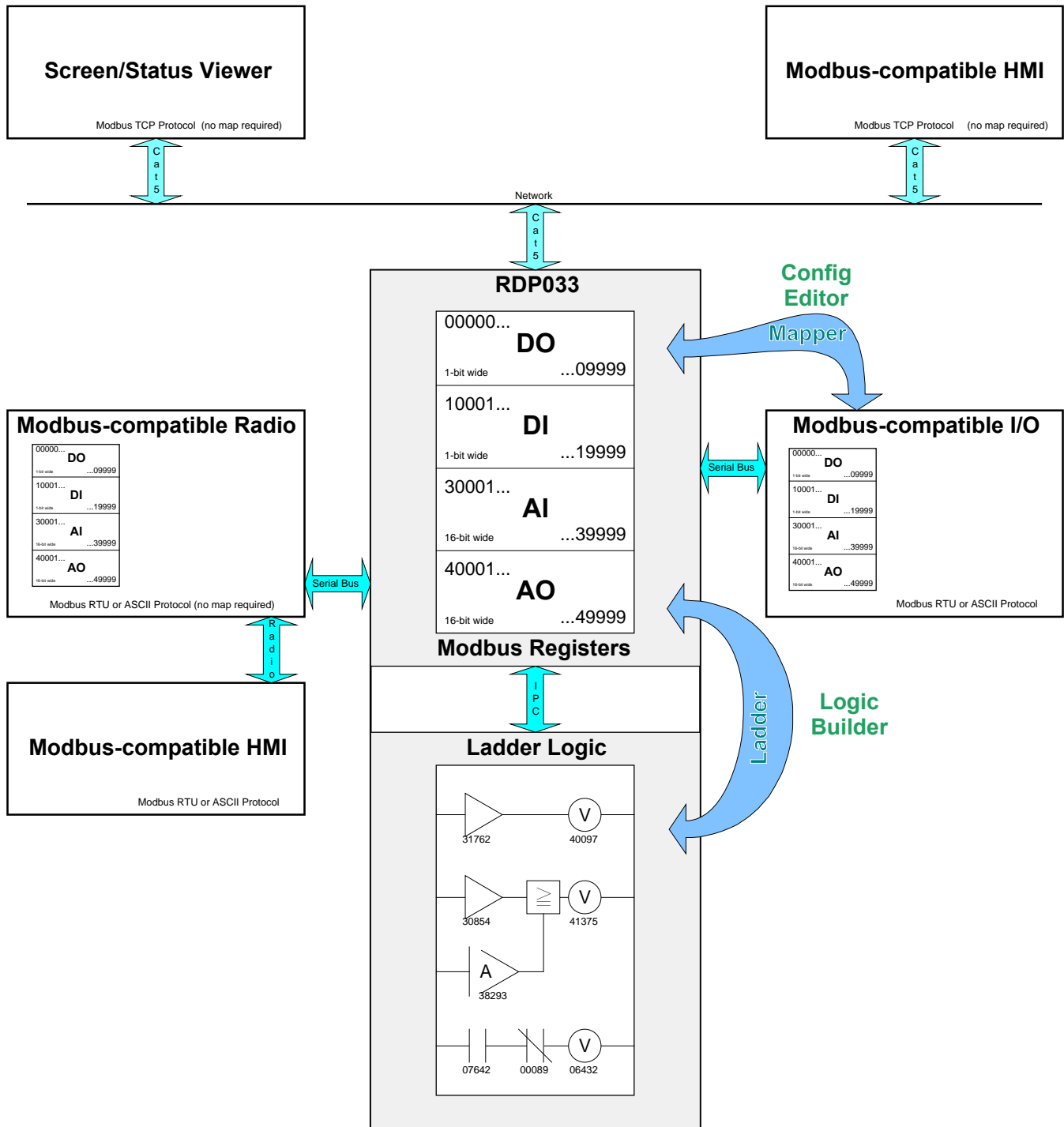

Figure 3-2, "Typical RDP180 Application"

Chapter 4: QUICK START GUIDE

1. Define the problem. What problem are you trying to solve by installing the RDP? What kind of I/O do you need? What do you need to monitor and control in the field? What information needs to be sent back to the central computer?
2. Install the RDP and all related hardware. Discussed in Chapter 5: Hardware Installation
3. Create a new project in the Project Management Toolkit and define the basic settings, including IP address and mode (RDP). Discussed in the *PMT User Manual*. Note that the RDP leaves the factory at the default IP address **192.168.1.10**.
4. Define ranges for the physical I/O, user-defined logical I/O (for example, virtual analog inputs and outputs you create in Logic Builder), and the logical I/O generated internally by Logic Builder. Be aware that the high end of the digital output and analog output ranges are reserved for user set points and special functions (see Chapter 1: Product Overview for more information).

We recommend the following:

Range Type	Digital Outputs	Digital Inputs	Analog Inputs	Analog Outputs
Physical I/O	1-1000	10001-11000	30001-31000	40001-41000
User-defined Logical I/O	1001-1999	11001-11999	31001-31999	41001-41999
System-generated logical I/O	2000-9799	12000+	32000+	42000-49799
Reserved set point registers	9800-9899	---	---	49800-49899
Special Function Registers	9900+	---	---	49900+

5. Add and configure the physical I/O using I/O Builder. Discussed in the *PMT User Manual*.
6. Map the physical I/O into the appropriate register ranges using the Mapper. Discussed in the *PMT User Manual*.
7. Transfer the mapped I/O to the RDP. Discussed in the *PMT User Manual*.
8. Create a ladder logic program that can locally control the hardware (monitor status, make decisions, perform calculations, etc.). Install the ladder in temporary memory during testing. When everything is working correctly, flash it to permanent memory. Discussed in the *PMT User Manual*.
9. Map logical I/O into the DFS Radio Map and transfer it to the RDP. (Optional; this step is only required if the RDP will be polled by a HyperTAC II system). Note that it isn't necessary to map all of the logical I/O; only the I/O that will be sent over the radio link. Discussed in the *PMT User Manual*.
10. (Optional for RDP180-1 with autodialer function.) Configure alarms and record alarm messages. Create list of personnel that the system will call when an alarm occurs.
11. Create custom screens that enable users to view the status of equipment or control set points. Discussed in the *PMT User Manual*.

Notes

Chapter 5: HARDWARE INSTALLATION

IMPORTANT:

A qualified technician should install the RDP.

The RDP is designed to be mounted in an industrial control panel with access limited to qualified personnel.

If the RDP is to be installed into an existing control panel, make sure that all breakers are shut off before starting the installation.

All wiring should conform to federal, state, and local electrical codes.

Attention should be given to the location of the RDP to provide accessibility for wiring and servicing. Allow room above and below the device to provide easy access.

MOUNTING THE RDP180

When mounting the RDP, either of the DIN-rail models listed below may be used.

- DIN EN 50025 (32mm asymmetrical)
- DIN EN 50022 (35mm symmetrical)

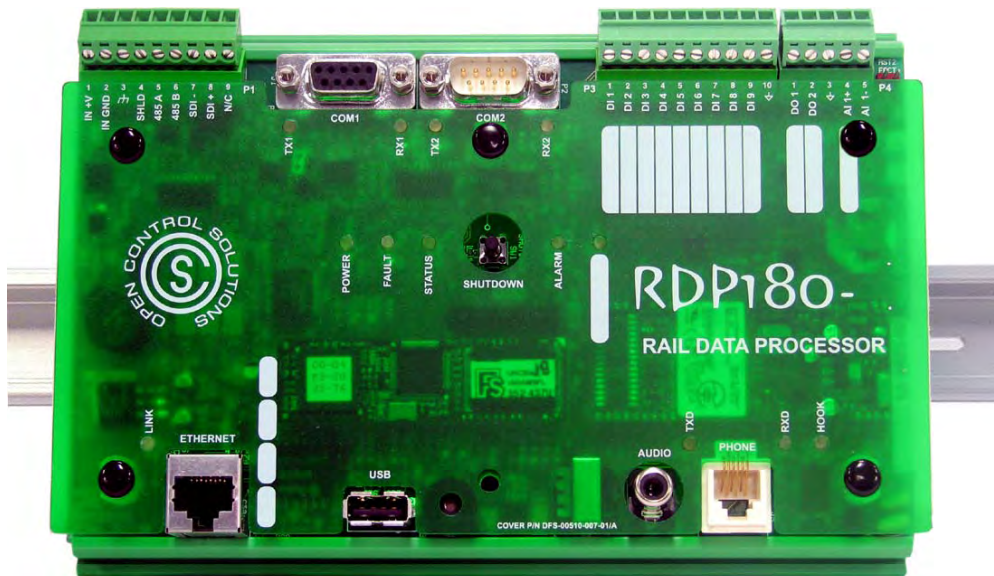

Hook the RDP on the top of the DIN-rail and press down to snap it into place.

POWER

The RDP operates from 10-16 VDC and is compatible with other components of the RAIL system.

The RDP can be powered with a 13.8 V power supply and backed up with a 3.0AH, 12V sealed lead-acid battery (see Appendix C: Parts List for ordering information).

Two terminals are provided for wiring power:

- P2-1, IN +V (incoming power)
- P2-2, IN GND (incoming power return)

Verify the input voltage on the RDP's connector label before wiring. Wire in accordance with Federal, State, and Local Electrical Codes.

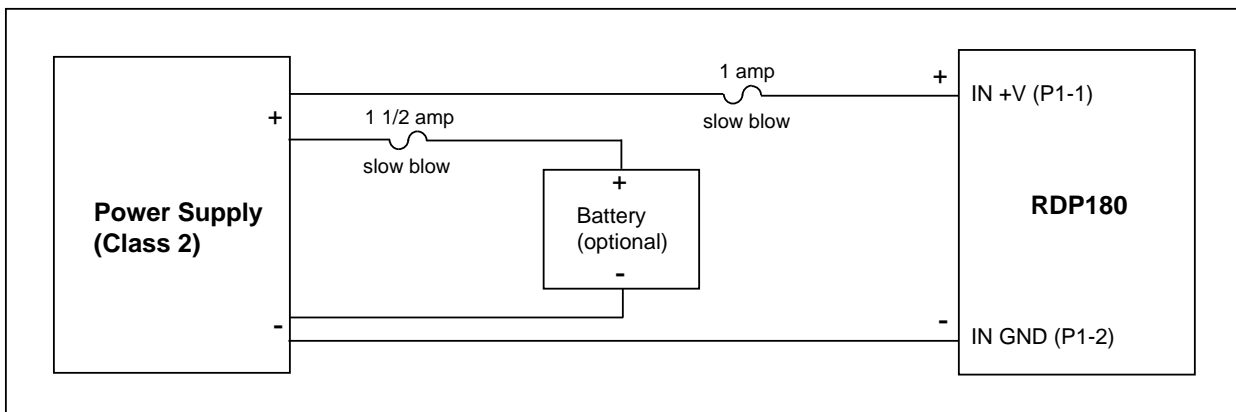

Figure 5-1, "Wiring DC Power"

ETHERNET INTERFACE

The RDP features a 10/100base-T network interface. This interface enables the RDP to operate as a network device that communicates using the Modbus TCP/IP protocol.

This interface is also used when configuring and programming the RDP. A standard network crossover cable with RJ-45 connectors is all that is needed in most cases to connect the RDP to a computer. However, if the RDP is going to stay on the network permanently, we recommend that you install a 100Base-T Network Surge Arrestor, which can be ordered from Data Flow Systems (DFS Part No. 002-0279).

MODBUS SERIAL INTERFACES

The RDP features two independent serial ports. One of these, COM1, may be used to communicate with Modbus-type serial master or slave devices, such as the RIO128/RIO032 RAIL I/O devices. The COM1 port can be used in either RS-232 or RS 485 mode. The RS-232 DCE port enables the RDP180 to support a single RS-232 device. Alternatively, COM1 can be used in RS-485 mode to support multiple RS-485 devices. The RDP can communicate with these devices using either Modbus ASCII or Modbus RTU protocol. When used in RS-232 mode, this port is designed for communication with a DTE device, but can communicate with a DCE device by using a null modem cable.

The second serial port, COM2 (available on the RDP180-2 model only), is an RS-232 DTE port for interfacing with a Modbus-compatible serial master or slave device, such as the RDR200 radio. This port is designed as an interface to a DCE device; however the COM2 port can also be used as an interface to a DTE device by using a null modem cable. Using this port, the RDP can communicate with devices using either Modbus ASCII or Modbus RTU protocol.

RS-232 DCE/RS-485 INTERFACE (COM1)

For RS-232 mode, use pins J1-2, J1-3, J1-5, J1-7, and J1-8; For RS-485 mode use Pins P1-4, P1-5, and P1-6.

Review the drawings below and on the next page before connecting a device to the COM1 port. Figure 5-2, “Wiring COM1 RS-232 DCE Interface” shows the RDP180’s COM1 RS-232 serial port connected to a DTE device. Refer to “Serial Cable Wiring Diagrams” on page 27 for additional information on wiring this serial port to a DCE device (null modem cable required).

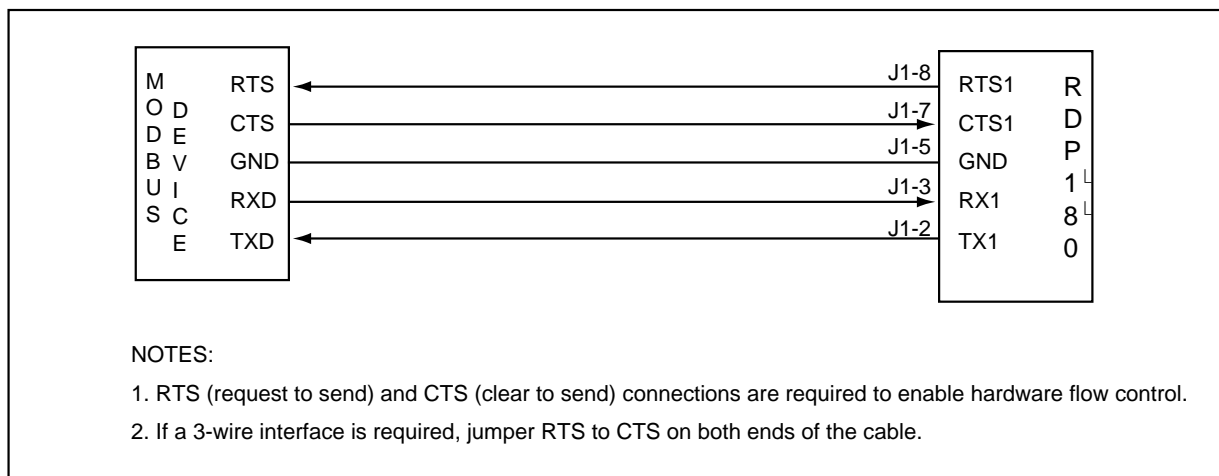

Figure 5-2, “Wiring COM1 RS-232 DCE Interface”

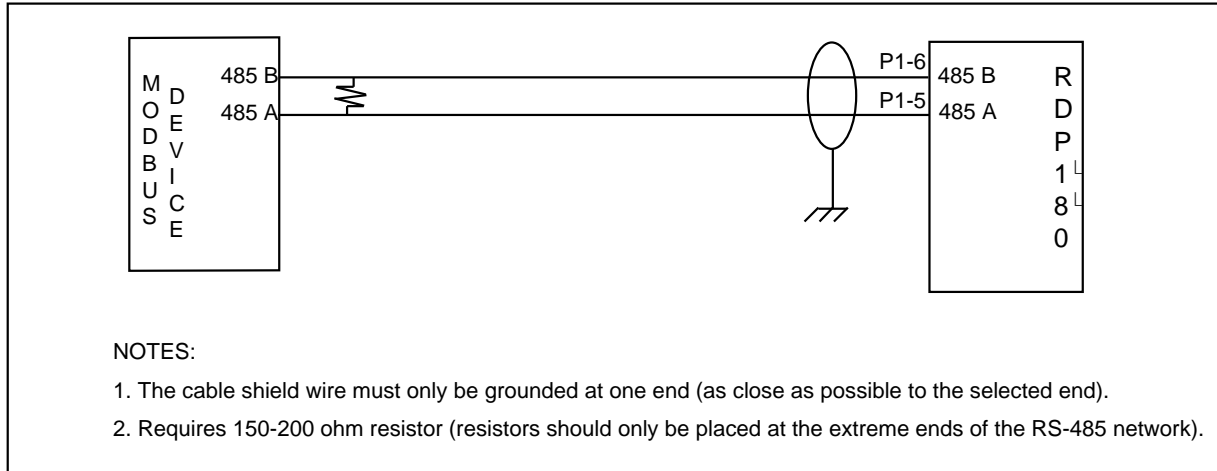

Figure 5-3, "Wiring COM1 RS-485 Interface"

RS-232 DTE INTERFACE (COM2)

Note: This interface is available on the RDP180-2 model only.

Pins P2-2, P2-3, P2-5, P2-7, and P2-8 are provided as an interface to a Modbus-compatible DCE device. The COM2 port can also be used as an interface to a DTE device by using a null modem cable.

Review the drawing below before connecting a device to the COM2 port. Figure 5-4, "Wiring COM2 RS-232 DTE Interface" shows the RDP180's COM2 port connected to a DCE device. Refer to "Serial Cable Wiring Diagrams" on page 27 for additional information on wiring this serial port to a DTE device (null modem cable required).

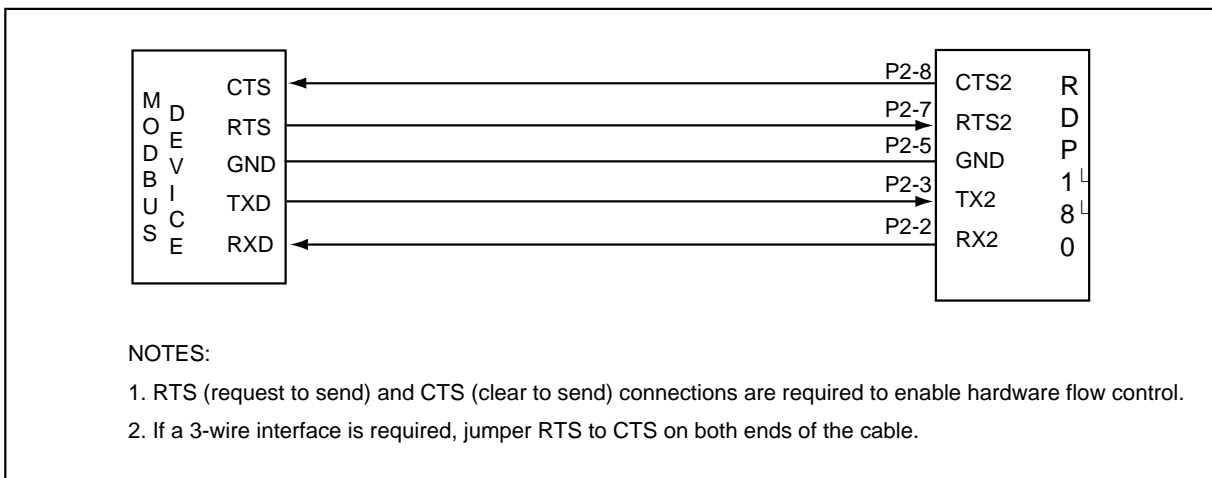
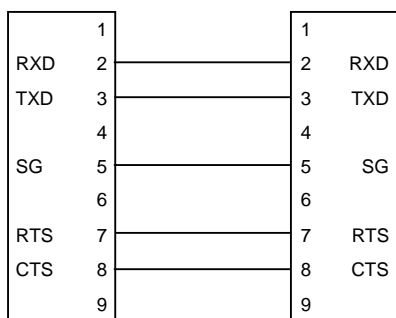

Figure 5-4, "Wiring COM2 RS-232 DTE Interface"

SERIAL CABLE WIRING DIAGRAMS

Pin #	Description
1	unused
2	RXD – receive data
3	TXD – transmit data
4	unused
5	SG – signal ground
6	unused
7	RTS – request to send
8	CTS – clear to send
9	unused

9-PIN TO 9-PIN SERIAL MODEM CABLE



9-PIN TO 9-PIN SERIAL NULL MODEM CABLE

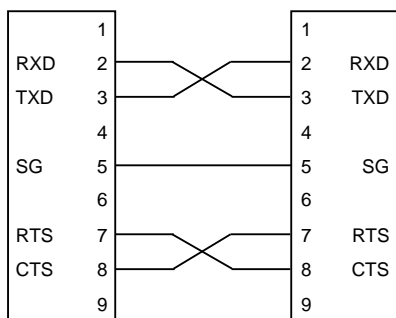

9-PIN TO 9-PIN SERIAL 3-WIRE MODEM CONNECTION

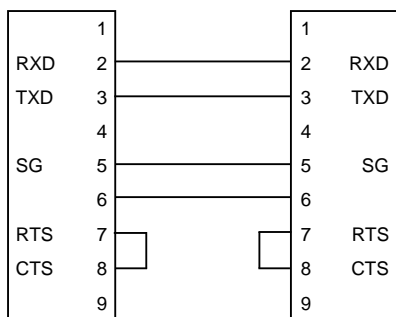

9-PIN TO 9-PIN SERIAL 3-WIRE NULL MODEM CONNECTION

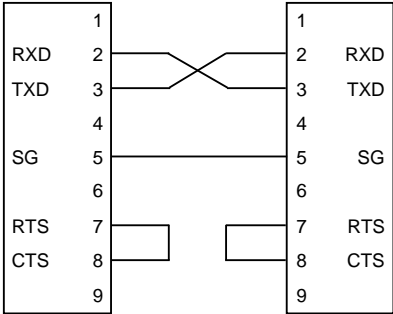

ONBOARD I/O

The RDP180 features onboard I/O: nine digital inputs, 2 digital outputs, and one analog input. Note that analog input can be used as digital I/O by sourcing 0 volts for off and 5 volts for on, and then creating a digital point in the ladder program.

DIGITAL INPUTS

The RDP180's nine digital inputs are closure-to-ground for on and are biased with 10-15 VDC raw power through an onboard 5.6 Kohm resistor. Digital inputs are processed at a rate of 120-samples-per-second with 100 mSec debouncing for on/off status. For pulse input accumulation, digital inputs are sampled at the raw 120 sample rate. The maximum input pulse rate is 30 Hz.

Pins for wiring digital inputs can be found on the P3 connector (10-pin pluggable screw terminal).

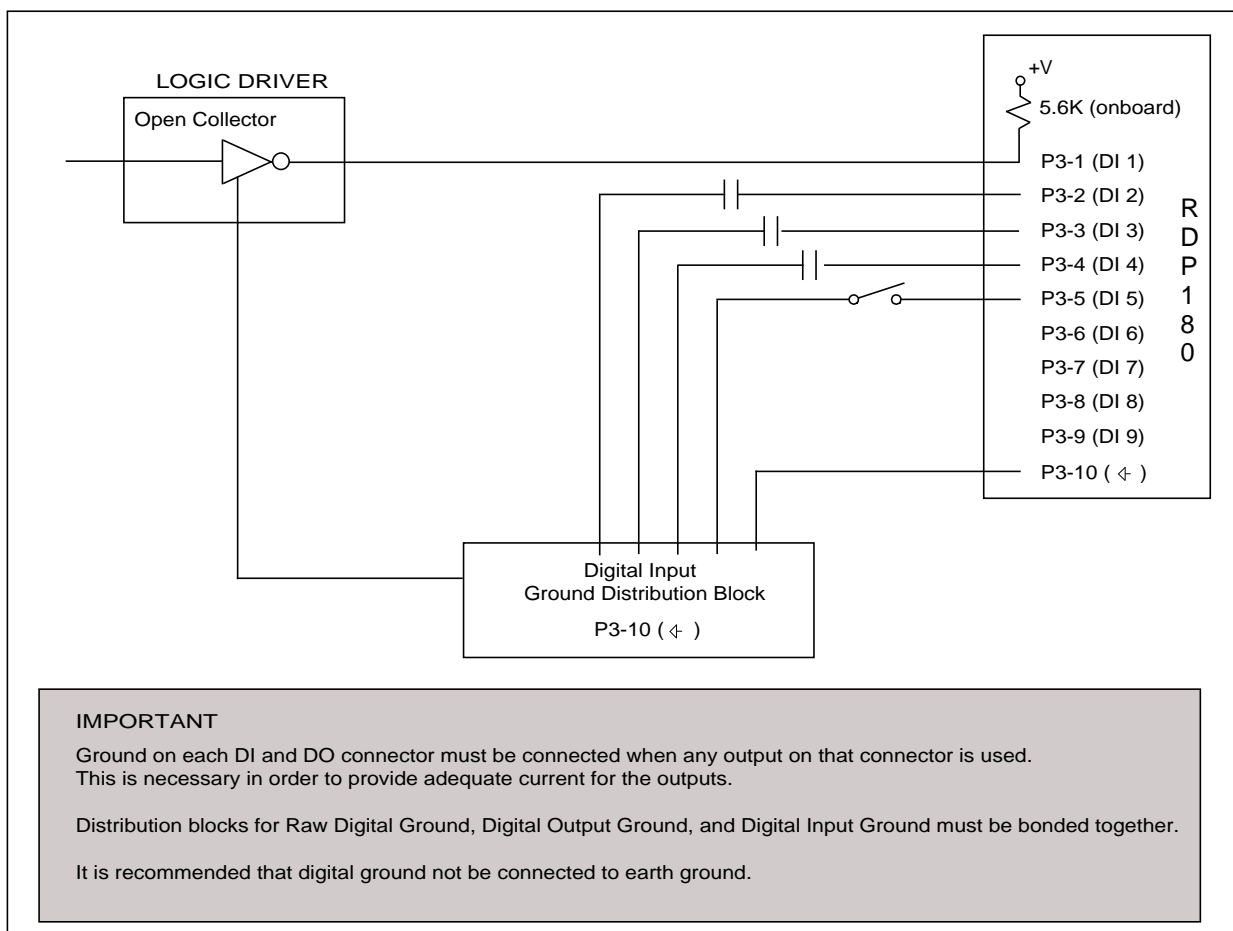

DIGITAL OUTPUTS

The RDP180's two digital outputs are open collector with current capability to drive 12 or 24 VDC, 80 mA constant duty, 300 mA in-rush current, ice cube-type relays.

Pins for wiring digital outputs can be found on the P4 connector (5-pin pluggable screw terminal).

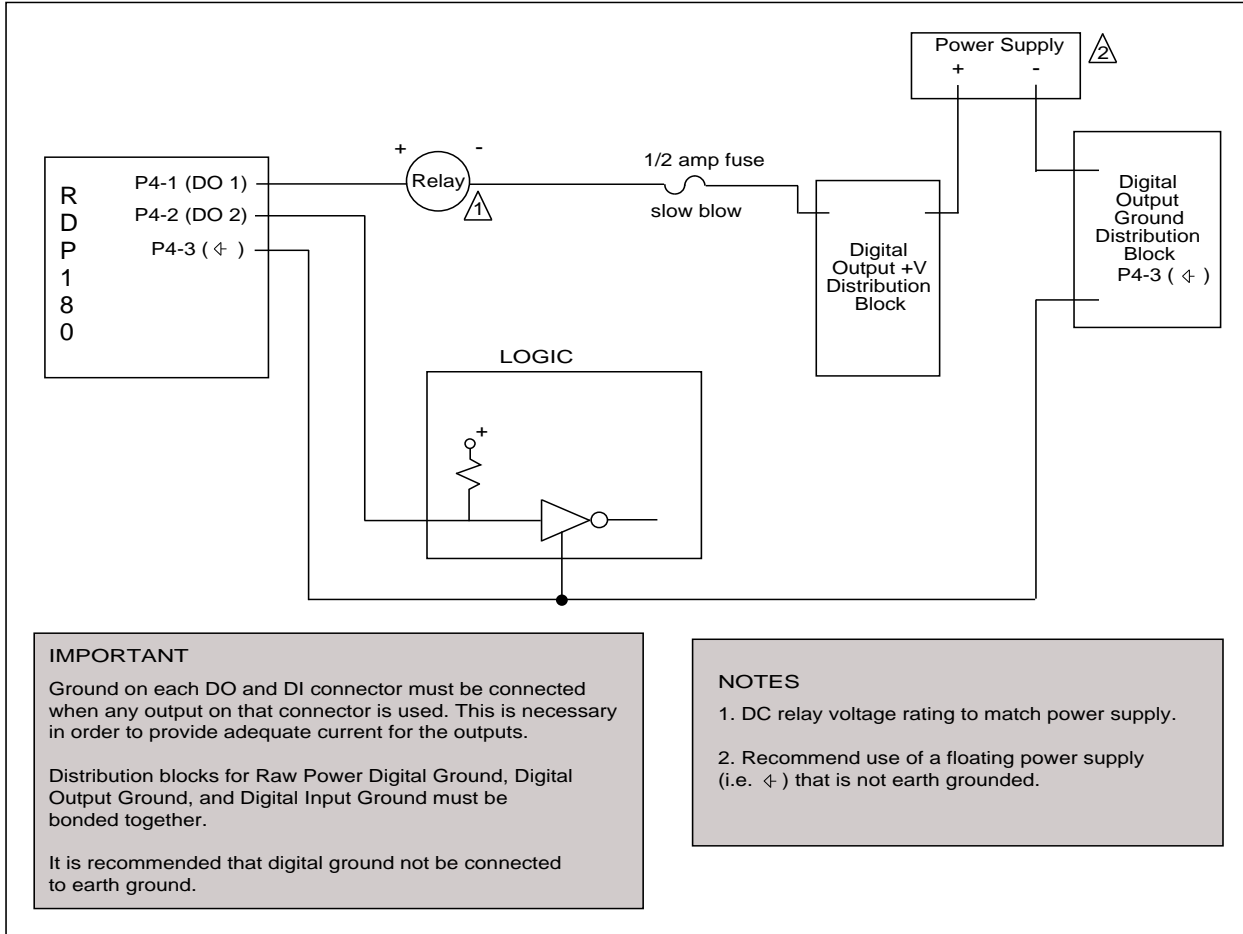

ANALOG INPUT

The RDP180's analog input has 12-bit resolution and is processed at a rate of 10-samples-per-second.

Pins for wiring digital outputs can be found on the P4 connector (5-pin pluggable screw terminal).

Note: The analog input can be used as digital I/O by sourcing 0 volts for off and 5 volts for on, and then creating a digital point in the ladder program.

ANALOG BIT FORMAT

The RDP180 has 12-bit resolution. The three least significant bits (LSB) are not taken into account. The table below explains the bit format.

		Bit	15	14	13	12	11	10	9	8	7	6	5	4	3	2	1	0	
		Value	32768 (sign)	16384	8192	4096	2048	1024	512	256	128	64	32	16	8	4	2	1	
mA	Raw																		
0	7		x	0	0	0	0	0	0	0	0	0	0	0	0	0	x	x	x
4	6552		x	0	0	1	1	0	0	1	1	0	0	1	1	x	x	x	
20	32767		x	1	1	1	1	1	1	1	1	1	1	1	1	x	x	x	

USING THE ANALOG INPUT AS DIGITAL I/O

The analog input can be used as digital I/O by sourcing 0 volts for off and 5 volts for on, and then creating a digital point in the ladder program (see example below).

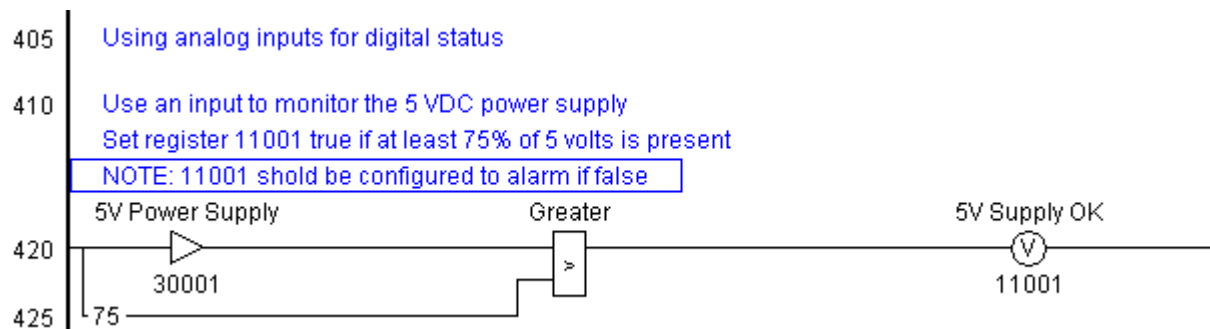

4-20mA / 0-20mA CURRENT LOOP

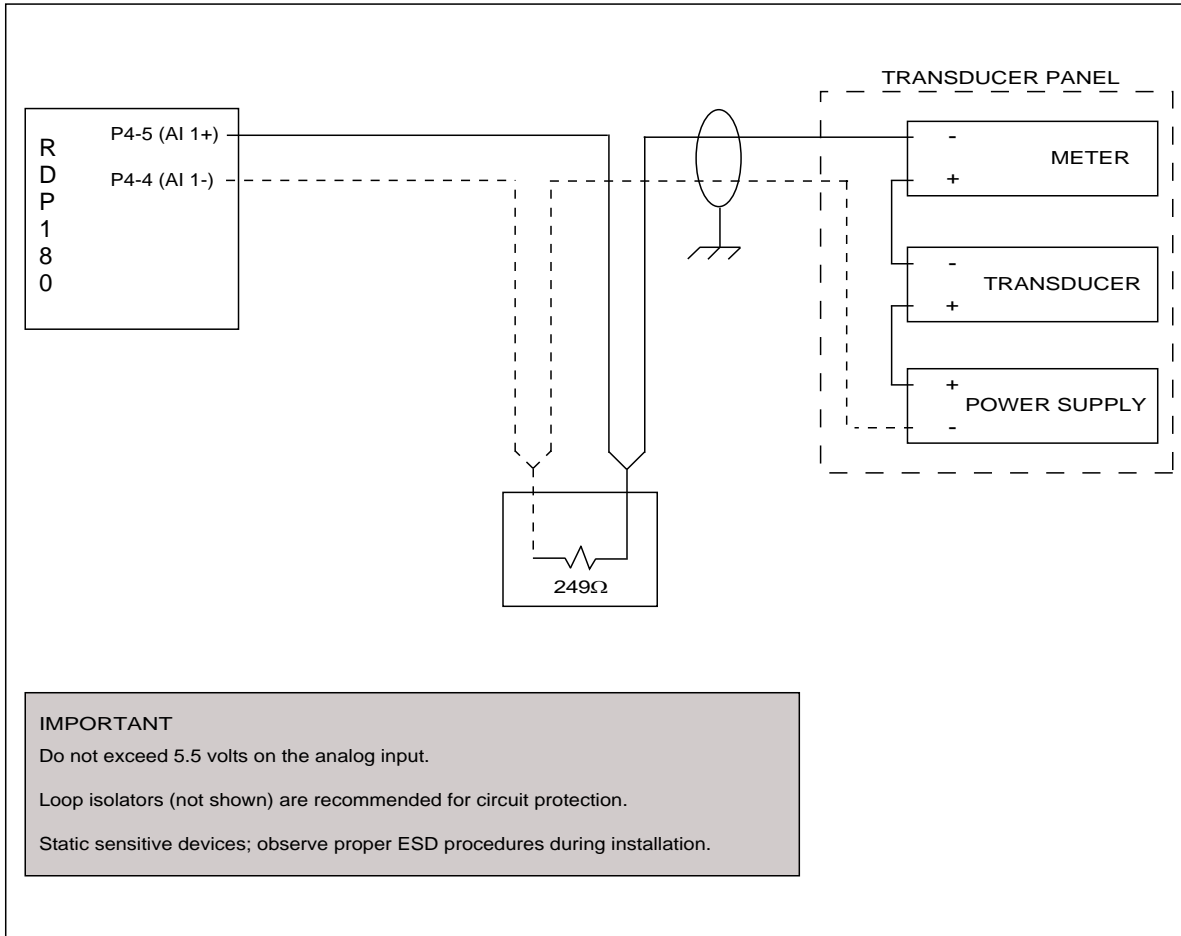

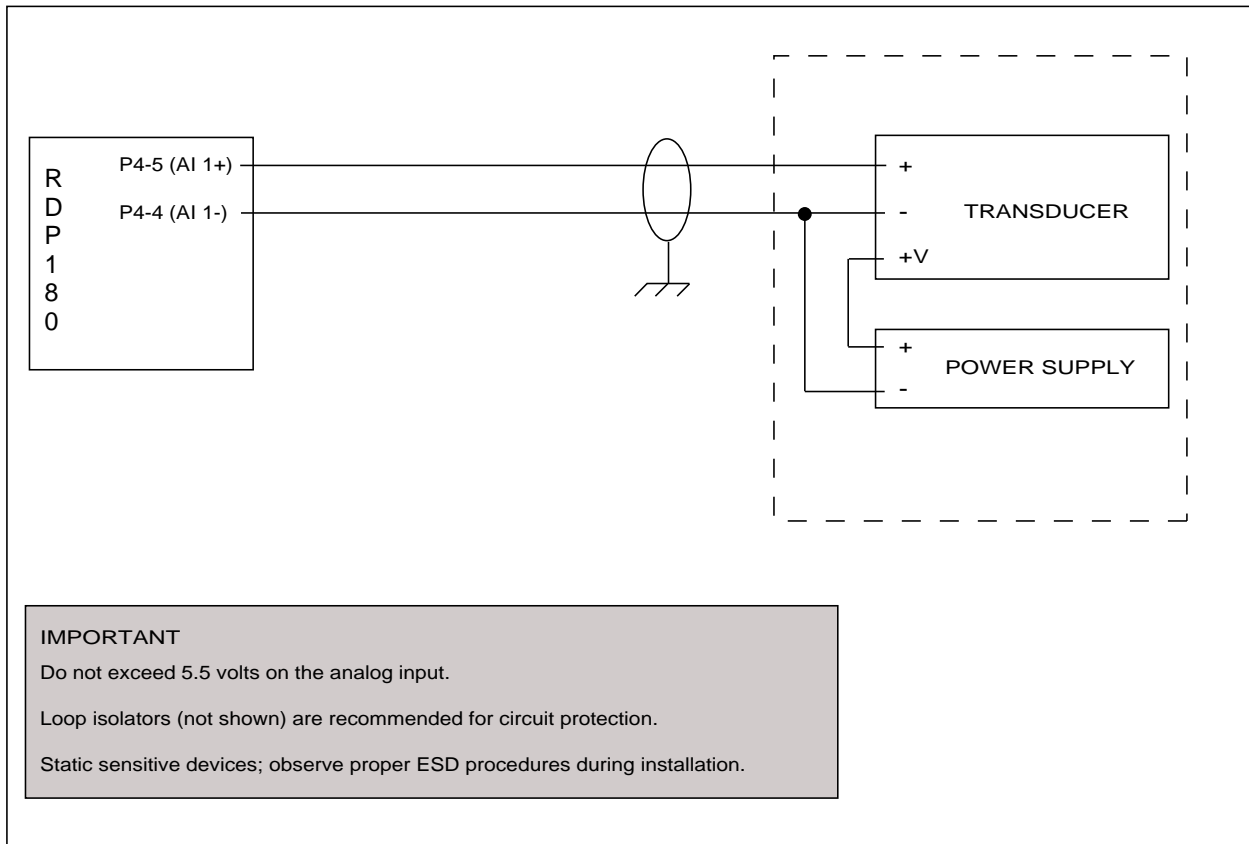
1-5V / 0-5V VOLTAGE SOURCE

Notes

Chapter 6: AUTODIALER

An optional onboard voice modem that is available on the RDP180-1 model enables the RDP180 to function as an autodialer and alert personnel of alarm conditions at RDP180-fitted stations.

When an alarm that has been configured for dial out occurs, the RDP uses its onboard, voice modem to call a series of contacts and announce the alarm via prerecorded voice messages. The alarm announcement includes the station number and a description of the alarm (for example, “high well”).

A code, similar to a PIN code, is used to prevent an unauthorized person from acknowledging alarms. The recipient of a call must enter a four-digit code, using the keys on their touch-tone phone, before any alarms will be announced. The RDP then announces the first alarm and prompts the recipient to press 1 (one) to acknowledge or press 2 (two) to replay the message. If there are multiple alarms, each will be announced once the preceding alarm has been properly acknowledged.

Any alarm condition can be enabled for call out by selecting the **Enable Dialout** option. Each alarm condition can be configured with a delay of up to 9,999 seconds (~167 minutes).

When there is an active alarm at the RDP station, the autodialer waits the configured delay time for that alarm and then dials the first number on the list. The autodialer calls each telephone number in sequence until all of the alarms are acknowledged.

Once an alarm has been acknowledged, the autodialer will not call out again unless the alarm clears and then becomes active again. If an alarm occurs and then clears within the alarm’s configured delay time, you will not be notified.

Once call out begins, all alarms are announced regardless of their current status – active or cleared – and they remain in the queue until they are acknowledged. The autodialer checks the status of all points between each phone call. If a call isn’t answered and an alarm clears before the next phone call is placed, the autodialer will change the status of the point to “cleared” and will announce it as such when the phone call is eventually answered. Similarly, if a new alarm occurs between calls, it will be added to the alarm list. Alarms will continue accumulating this way until they are all acknowledged.

Before any alarms are announced, the recipient is given three opportunities to enter the correct acknowledgement code. Once the correct code is entered, the autodialer begins playing voice messages for each alarm condition.

After each alarm message is played, the call recipient is prompted to press 1 (one) on the phone’s keypad to acknowledge the alarm or to press 2 (two) to replay the message. If the alarm isn’t acknowledged after it is announced for the third time or if the time out period expires, the autodialer will hang up and call the next number on the list.

If the autodialer gets to the end of the list and there are still unacknowledged active alarms, it cycles back to the first telephone number. This process is continued until all of the alarms have been acknowledged.

Alarms, contacts, and recordings are created using the Process Management Toolkit. See the *Process Management Toolkit User Manual* for instructions.

DIAL OUT PROCESS

12. Dial out-enabled alarm occurs.
13. The alarm delay timer starts counting down. When the timer expires, the autodialer starts the call out process.
14. If the call is answered, the welcome message is played (includes station number) and the user is prompted to enter the four-digit acknowledgement code. The user is given three opportunities to enter the correct code. If the user fails to enter the correct code or the call is not answered, the autodialer hangs up and continues to the next number in the dial out list.
15. When a successful call out connection is made and the correct acknowledgement code is entered, the autodialer begins announcing alarms.
16. After each alarm is announced, the user is prompted to press 1 (one) to acknowledge the alarm or 2 (two) to replay the message. The message will be played a maximum of three times. If the alarm isn't acknowledged after the third time, the autodialer will hang up and call the next number in the dial out list.
17. If there is more than one alarm, the autodialer will announce each alarm after the previous one is acknowledged.

Note: The autodialer will only call one time for a specific alarm regardless of how long the alarm remains active. Once an alarm is acknowledged, it is the user's responsibility to ensure that the alarm has cleared. The autodialer will not call out for that type of alarm again unless the alarm clears and then becomes active again.

CONNECTING THE RDP TO A PHONE LINE

COMPATIBLE PHONE SYSTEMS

The RDP is compatible with analog, or POT ("plain old telephone"), systems only.

It is important that you not connect the RDP to a digital-type system – doing so will cause damage to the RDP. If you are unsure what type of system you have, contact the person or department that oversees your telephone system before connecting the telephone line to the RDP.

PHONE LINE CONNECTION

The RDP comes equipped with a short length of telephone cable terminated with a standard RJ-11 modular plug and female-to-female coupler for connecting to a dial-out telephone line.

The telephone line connected to the RDP should be a dedicated line. The line should not be shared with another telephone or telephone-enabled device.

We recommend that you install a surge arrestor between the telephone line and the RDP to protect the unit from damage from electrical surges.

RECEIVING AND ACKNOWLEDGING AN ALARM CALL

When you answer a call from the autodialer, you will first hear a welcome message that includes the station number of the station in alarm.

The autodialer will then prompt you for the one- to four-digit acknowledgement code. You are given three opportunities to enter the correct code. If you fail to enter the correct code on the third try, the autodialer will play a good-bye message and hang up. It will then call the next telephone number in the dial out list.

Once you have entered the correct acknowledgement code, the autodialer will play the first alarm message. You will then be prompted to press 1 (one) to acknowledge the alarm or 2 (two) to replay the message. The autodialer will only play the message a maximum of three times. If you don't acknowledge the alarm after the third time the message is played, the autodialer will play the good-bye message and hang up. It will then call the next number in the dial out list.

If there are additional alarms at the station, the autodialer will play the message for the second alarm and will again prompt you to acknowledge or replay. It will continue this sequence until either all alarms have been acknowledged or the session ends because you didn't acknowledge an alarm within the three time maximum.

When all alarms have been acknowledge, the autodialer will play the good-bye message and end the call.

Notes

Appendix A: TESTING AND TROUBLESHOOTING

No COMMUNICATION TO RS-232/485 MODBUS DEVICES

If you are having problems communicating from the RDP to RS-232 or -485 Modbus-compatible devices, you can perform a “data tap” to determine if the problem is hardware related. A data tap is performed using a standard Telnet connection. It enables you to view outgoing and incoming messages from the RDP to the Modbus-compatible devices connected to its COM1 and COM2 ports. If messages are going out from the RDP to the devices but no messages are coming in, the problem may lie with the configurations (Were they uploaded to the RDP? Are they correct?), the connection to the device (Is it connected properly? Is the cable damaged?), or with the device itself.

1. Open a Telnet connection by selecting Run from the Windows Start menu and typing

```
telnet xxx.xxx.xxx.xxx 504
```

Where xxx.xxx.xxx.xxx is the IP address assigned to a RDP that is on the network. If you are using a closed network to connect to the RDP (crossover cable between the RDP and the computer), change the network settings for your computer so that it is on the 192.168.1 network (for example, set the computer to 192.168.1.101) and telnet to the default IP of 192.168.1.10.

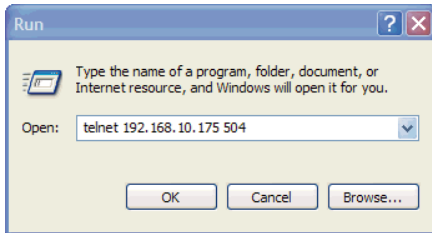

2. Click OK to open a Telnet connection. A Telnet window opens with instructions for testing the COM1 or COM2 port.

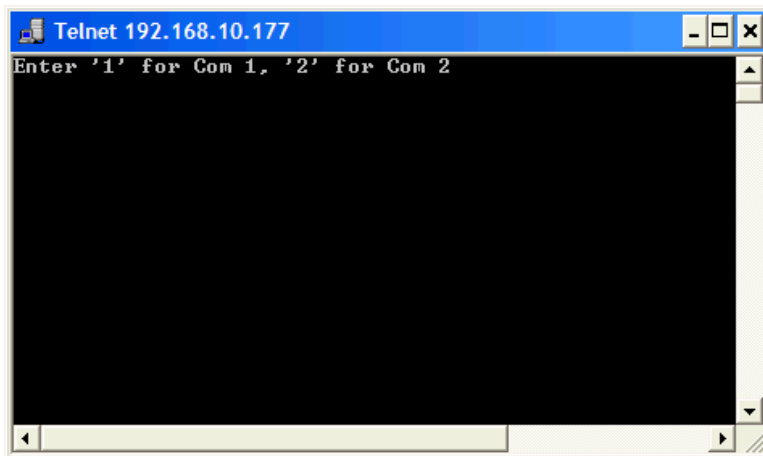

(continued on next page)

BROADCAST RDP IP

If you need to find out the IP address to which the RDP is set, you can have it broadcast the IP and view the results in a terminal program such as Hyper Terminal. This may be necessary if you've forgotten the RDP's IP. The only solution in that case is to either have the RDP broadcast its IP or reset the RDP to its factory default state (see "Reset RDP to Factory Default State" on page 42).

1. Power down the RDP.
2. Place a jumper on pin JP6 (RST2 FACT).

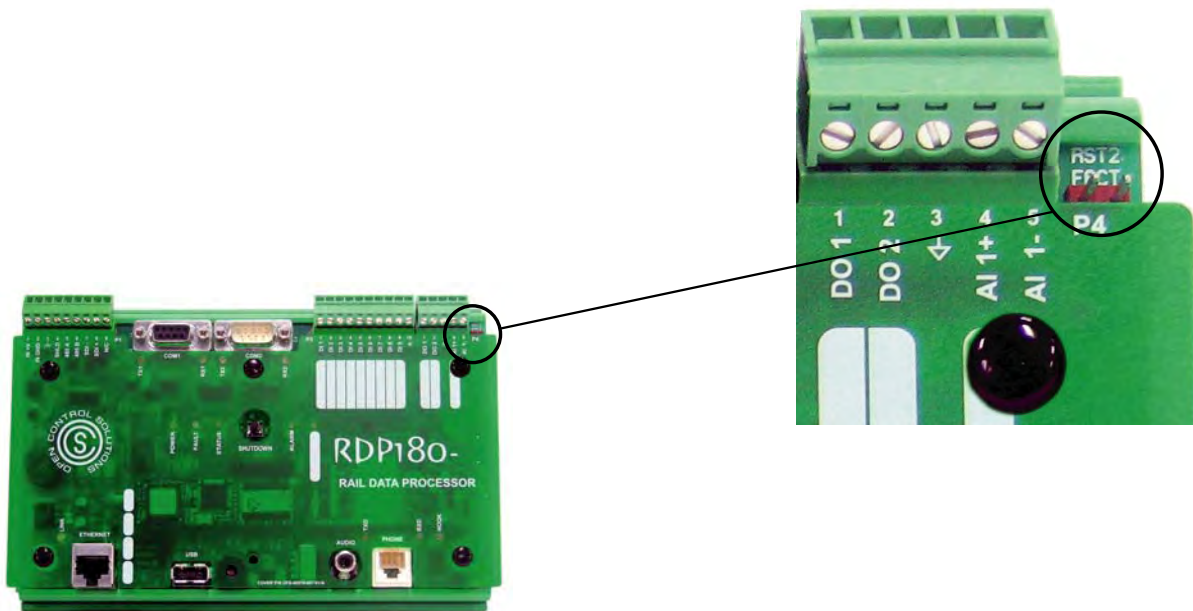

Figure 6-1, "Pin JP6 (Broadcast IP)"

3. Using a service cable, connect a laptop to the RDP's COM1 port.
4. Start a terminal program session (e.g., Hyper Terminal).
 - Bits per second = 38400
 - Data bits = 8
 - Parity = None
 - Stop bits = 2
 - Flow control = None
5. With the jumper in place, power the RDP. Observe the status LED. The blinking pattern will be 8 quick flashes followed by a pause to indicate the RDP has been started in reset mode.

IMPORTANT: Do not remove the jumper while the RDP is powered. This will result in the RDP being reset to its factory default state. All configurations will be deleted and the IP address will be reset to 192.168.1.10.

6. The RDP's IP address should be displayed on the terminal program's screen along with the message "Reset to Factory Default on Jumper Removal."

7. When the RDP's IP address has been verified, power down the RDP and then remove the jumper.

RESET RDP TO FACTORY DEFAULT STATE

It is possible to reset the RDP to its factory default state. When this is done, all of the configurations, including the ladder program, are deleted and the RDP's IP is reset to the default IP address of 192.168.1.10.

1. Power down the RDP.
2. Place a jumper on pin JP6 (RST2 FACT).

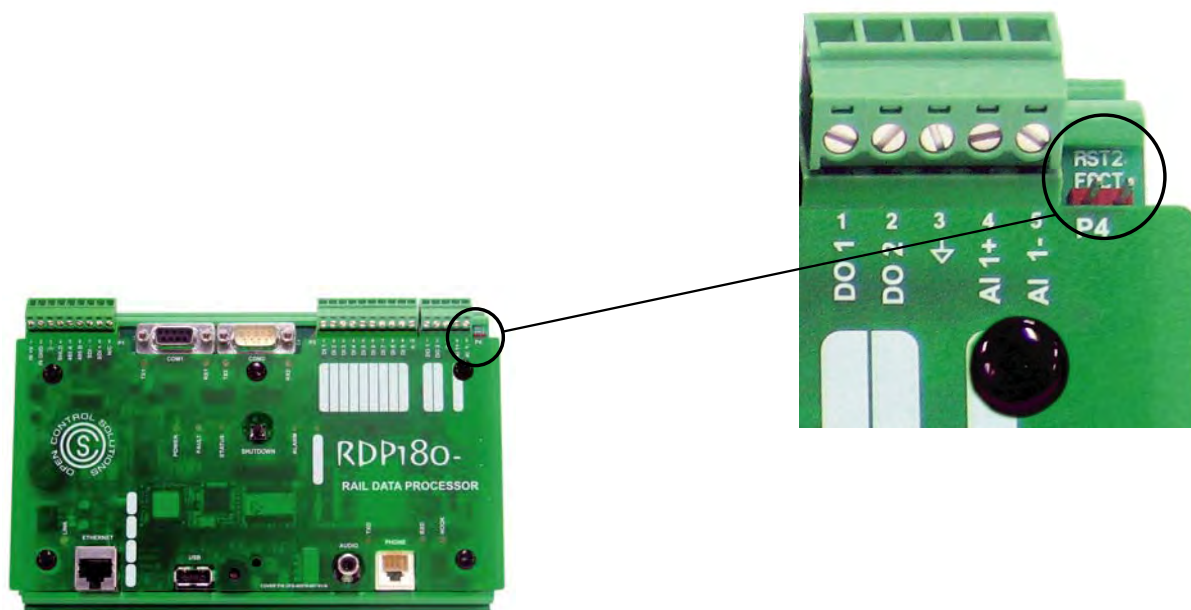

Figure 6-2, “Pin JP6 (Return to Factory State)”

3. With the jumper in place, power the RDP. Observe the status LED. The blinking pattern will be 8 quick flashes followed by a pause to indicate the RDP has been started in reset mode.
4. Remove the jumper with the RDP still powered. Observe the status LED. The blinking pattern will be 5 quick flashes followed by a pause to indicate the RDP is going through the reset process. The LED will turn off for approximately 30 seconds and then will return to its normal blinking pattern (slowly turns on and then off).
5. Using a crossover cable, connect a laptop to the RDP. (You may need to change the network settings for your computer so that it is on the 192.168.1 network. For example, set the computer to 192.168.1.101). Issue a PING command to the factory default IP (192.168.1.10) to verify that the factory default reset was successful.

CONTROLLED SHUTDOWN OF PROCESS (LADDER)

There are several ways to stop the RDP's ladder:

- Battery voltage drops to 11.2 volts
- RDP's Shutdown button is pressed for several seconds
- Remote Process Stop Command register (Special Function Register 9921) is set to true via logic. This could be a condition in the RDP's own ladder that prompts the ladder to set the register itself or a control on a Modbus master device that sets the register over the radio or network.

In all cases, the ladder is given 30 seconds to perform any actions necessary to put the station in a safe state and set the Remote Process Running register (Special Function Register 9930) to false. When the RDP sees that register 9930 is false, it will stop running the ladder in preparation for a physical shut down (e.g., power to the RDP is turned off). If the 30 second timer expires before the ladder sets register 9930 to false, the RDP will set the register itself and stop running the ladder.

LOW BATTERY VOLTAGE

The RDP is designed to monitor the backup battery's voltage. If it senses that the voltage has dropped to 11.2 volts, the RDP will set the Remote Process Stop Command register (Special Function Register 9921) to true. The RDP will stop running the ladder when one of two conditions occurs: it sees that the ladder has set the Remote Process Running register (Special Function Register 9930) to false or 30 seconds has expired (in this case the RDP itself sets register 9930 to false).

When the process stops due to low battery voltage, you will have to restart the ladder by powering up the RDP, since a loss in voltage is likely caused by loss of AC power.

SHUTDOWN BUTTON

The RDP features a shutdown button that can be used to stop and start the ladder. The button can be found on the bottom edge of the RDP180 near the Power, Fault, and Status LEDs.



Holding the button down for several seconds sends a signal to the RDP to turn on the Remote Process Stop Command register (Special Function Register 9921). The RDP will stop running the ladder when one of two conditions occurs: it sees that the ladder has set the Remote Process Running register (Special Function Register 9930) to false or 30 seconds has expired (in this case the RDP itself sets register 9930 to false).

To restart the ladder, simply hold down the shutdown button again. This sends a signal to the RDP to turn on both the Remote Process Start Command register (Special Function Register 9920) and the Remote Process Running register (Special Function Register 9930). The RDP then starts running the ladder again.

LOGIC

The RDP's ladder can be stopped and started using logic via the Process Special Function Registers:

- Process Start Command – register 9920
- Process Stop Command – register 9921
- Process Running – register 9930

For example, you could create controls on a Modbus HMI that were mapped to registers 9920 and 9921. This would allow you to turn a ladder off and on from a remote location over the radio or network telemetry link. When the ladder sensed that the Remote Process Stop Command register was true, it could initiate actions to put the station in a safe state for shutdown. The ladder would then be programmed to turn off the Process Running register, which lets the RDP know that it is safe to shutdown the ladder. However, if the RDP doesn't see that the Process Running register has been turned off within 30 seconds of the Process Stop Command coming on, it will turn off the register and stop the process on its own.

You could also have a section in your ladder that would turn on the Process Stop Command register when a certain condition occurred. The ladder could be restarted by pressing the Shutdown button for several seconds or via telemetry through a control mapped to the Process Start Command register.

Appendix B: UPDATE RDP FIRMWARE

From time-to-time, OCS will make updates to the RDP's firmware (the ROM-based software that controls the device). These updates may add new features to the operation of the RDP or may fix bugs in the previous release. When updates are available, they will be placed on our server and can be downloaded and installed on the RDP via the **Update** command in the Process Management Toolkit.

To update the RDP's firmware, you must be on a computer that has access to the RDP you want to update. An Internet connection is optional but preferable. If you are connected to the Internet, you are ensured of getting the latest firmware updates. Without an Internet connection, PMT will update the RDP with any applicable updates that have been stored locally from a previous download. Files are stored locally in a folder in the main PMT directory.

When you initiate the update process, PMT attempts to connect to our server. After successfully connecting to our server, it compares the files on our server to those stored in the local PMT directory. Any updates not found in the local folder are downloaded. If no Internet connection is found, only the locally stored files will be used to update the RDP. After downloading the updates, the PMT connects to the RDP, compares the RDP's current firmware to the locally stored update files, and then makes the necessary updates.

Firmware updates are typically 1-2Mb, although the file size could be smaller or larger depending on the changes that have been made.

FIRMWARE UPDATE PROCEDURE

Note: If you will be updating more than one RDP, a connection to the Internet is only required for the first device. Once the update files have been downloaded to the PMT folder, you can update the remaining RDP's without being connected to the Internet; they can be updated using the locally-stored files.

1. Start PMT and open the project file for the RDP you want to update.
2. Select **Update PLC/RDP** from the **Network** menu. The dialog box will show the download progress (to the PMT folder).
3. When the updates have finished downloading, a second dialog box will show the file upload progress (to the RDP). When the transfer is complete, click **Done**.
4. Reboot the RDP (cycle power) to finalize the updates.

Notes

FURNISHED PARTS

RDP180

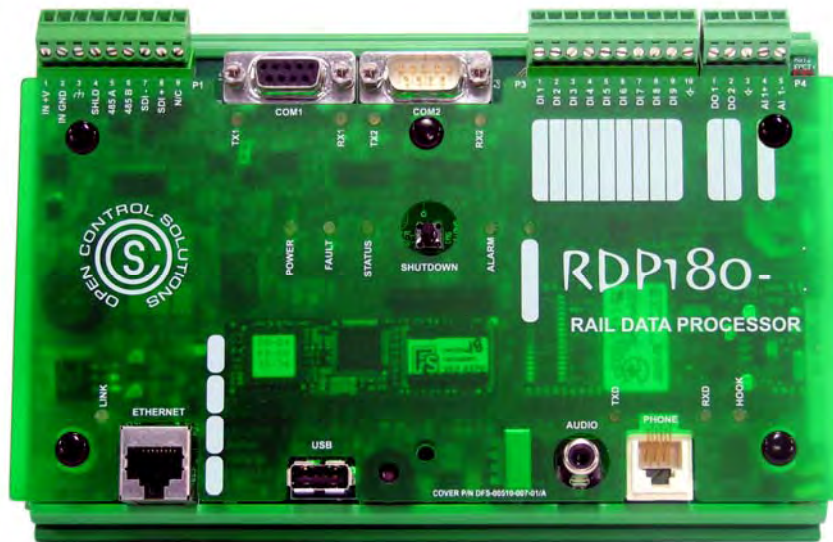

Part No. DFS-00510-008-1

(RDP180-1 with ARM7 processor, 8 MB Flash ROM, 16 MB RAM, one serial port, voice modem)

Part No. DFS-00510-008-2

(RDP180-2 with ARM7 processor, 8 MB Flash ROM, 16 MB RAM, two serial ports)

OPTIONAL PARTS

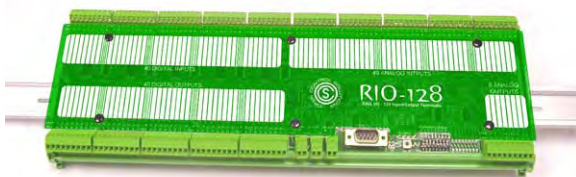

RIO128

Part No. DFS-00398-008-01.



RIO032

Part No. DFS-00398-008-02

Appendix C: Parts List



RDR200
Part No. DFS-00399-011



RNA110 Serial-to-Network Protocol Converter
Part No. DFS-00512-008-01



100Base-T Network Surge Arrestor
Part No. 002-0279



12VDC Power Supply
DR-120-12 (12V)



3.0AH, 12V Sealed Lead-Acid Battery
Part No. 023-0024

March 7, 2008 Release

New Features

1. The PLC033 can now emulate up to two DFS RTUs. This allows developers to exceed the 15 module maximum for DFS RTUs. This is accomplished in the Radio Map by right-clicking the main branch and selecting Add Remote Device. It is recommended that you choose the next station number after the physical address of the station the PLC is installed in, and that you configure the second station's RIM type as RIM004 in HyperTAC II. (e.g. If the PLC is in RTU #17 then add remote device #18 in the Radio Map). The RTU will now respond as station 17 and 18 in HyperTAC II.
2. The PLC033 and RDP180 now have a configurable Modbus slave device address for serial slave function. This is configured in the settings panel of PMT as the Slave Device #. Prior to this change the PLC/RDP would respond to any serial messaging. This feature allows the PLC/RDP to operate as a serial slave device on 485 or radio networks where there is more than one slave device.
3. System variable addresses can now be obtained from logic builder. This is accomplished by right-clicking the desired object. Previously there was no easy way of determining what address the builder had assigned un-addressed objects in the ladder.
4. The PMT is now the tool used to update the RNA110. This is accomplished by selecting Updated RNA from the Network menu. This works similarly to the update RDP/PLC function. The PMT obtains the update from our FTP server, but it prompts the user for the IP address of the target RNA110 before installing the update.

Fixes

1. Ladders that had rungs of logic too large to fit on a single page would not print. The printing method was overhauled to correct this and print ladders more efficiently.
2. Analog registers were not being removed and/or recreated in the points list properly. The PMT now performs a complete re-build of the points list each time a ladder check or install is performed. This process is reflected with a "busy" progress bar at the bottom left of the PMT status bar.
3. Q Points were not being properly added to the logic file. This fix only applies to the PLC033.
4. A scaling error was corrected for analog points on the screen builder.
5. A math error was corrected with the flow totalizer object.

A condition that caused the PLC/RDP to intermittently crash when used as a Modbus TCP slave device with HyperTAC II was corrected.

Notes

Appendix E: SUPPORT, SERVICE, AND WARRANTY

SUPPORT AND SERVICE

Open Control Solutions offers support services nationwide from its home office and through authorized representatives. Contact your local Open Control Solutions representative for:

- Sales and order support
- Product technical training
- Warranty support
- Support service agreements

If you are unsure of whom to contact, call OCS' Melbourne headquarters at 321-435-5010 and ask for the Sales Department. Alternatively, send email to sales@opencontrolsolutions.com.

TECHNICAL PRODUCT ASSISTANCE

Please review the information in Appendix A: Testing and Troubleshooting, before contacting Open Control Solutions. If you need further assistance, contact your local Open Control Solutions representative. If you are unsure of whom to contact, call OCS' Melbourne headquarters at 321-435-5010 and ask for the Sales Department. Alternatively, send email to sales@opencontrolsolutions.com.

RETURN AUTHORIZATION (RA) PROCEDURE

Open Control Solutions' products are designed to be robust and highly reliable. We back this performance with a three-year full warranty (see our warranty statement for details). In the event that a product fails, during or after the warranty period, it may be returned to Open Control Solutions to be repaired or replaced.

All RA's will be subject to standard shipping and handling charges. Standard shipping and charges will be based on UPS ground. Please advise if other arrangements are needed (UPS Red, FedEx, Pickup, Freight, etc.) Standard cost of repairs and shipping charges can be obtained by contacting our Sales Department by phone or e-mail.

STEP 1: Replace the failed module with a spare module of the same type, if one is available.

STEP 2: Contact Open Control Solutions, Inc. in one of the following ways to receive RA #.

E-mail – RA # can be obtained by e-mailing OCS at sales@opencontrolsolutions.com and must include the following information.

- Customer/Utility Name and Ship to Address
- Contact Name and Phone Number
- Products to be returned and Serial Numbers
- Detailed description of failure
- PO#

Phone – RA# will be issued over the phone by calling OCS at 321-435-5010 during normal operating hours. The following information will be needed.

- Customer/Utility Name and Ship to Address
- Contact Name and Phone Number
- Products to be returned and Serial Numbers
- Detailed description of failure
- PO#

Note: The lack of “Detailed description of failure” could result in the return of equipment due to the inability to properly determine the nature of the failure or testing resulting in “No Problem Found”

STEP 3: Place the function module(s) individually in an electrostatic discharge bag and then wrap with foam or bubble wrap. Pack the wrapped module(s) in a sturdy box filled with popcorn-type or bubble wrap packing material. Include a packing slip with the following information:

- Module(s) model, serial number, probable cause of failure, and the RA number
- Shipping address
- Shipping instructions (shipping costs greater than UPS ground are charged to the customer)

STEP 4: Address the box to:

RA Department # {the RA number you received here}
Open Control Solutions, Inc.
605 N John Rodes Blvd.
Melbourne, FL 32934-9105

STEP 5: Ship the box to OCS using any typical shipping carrier (for example, UPS, FedEx, etc.). If circumstances permit, have an OCS employee hand carry the package to the headquarters for you.

Note: OCS employees are not permitted to hand carry unpacked products.

Products are typically repaired and shipped back to the customer within a 2-week period starting at the time the product reaches the RA Department. If additional information is required during the repair of the product(s), the OCS RA department will contact you.

To get information on the progress of any of your equipment in for repair, contact the OCS Sales Department at sales@opencontrolsolutions.com or 321-435-5010.

Replacement of equipment may be necessary in the event that the equipment and/or parts are unrepairable. Warranty equipment will be replaced without prior notification as warranty replacement.

The customer will be notified by phone if equipment not under warranty cannot be repaired with information on available options.

OCS reserve the right to return any material received without RA # or not conforming to the requirements of this RA process.

WARRANTY STATEMENT

PRODUCT WARRANTY

Open Control Solutions (OCS) labeled products carry a (3) year return-to-factory warranty against defects in material and workmanship. OCS will repair or replace at its option, F.O.B. Melbourne, Florida, any part or parts of its products, which become defective during this warranty period. When returning parts to OCS, a Return Authorization (RA) must be obtained by contacting our Melbourne Factory Repair Center via telephone at 321-259-5009 or by email at rma@dataflowsys.com.

HT3 SCADA SOFTWARE WARRANTY

The HT3 SCADA Software is warranted for as long as it is in use by the Owner. All HT3 SCADA Software upgrades are provided to the Owner and are performed free of charge, but they must be installed by an authorized service technician. If remote access to the SCADA server is available via a VPN or dial-up connection, our service department will perform all upgrades free of charge. Please open a service ticket to coordinate a time to perform the remote upgrade. If remote access is not available, or if preferred, an on-site upgrade can be performed. Please request a quotation by contacting our Service Department via telephone at 321-259-5009 or by email at service@dataflowsys.com.

ONSITE INSTALLATION WARRANTY

When an OCS product has been installed and/or on-site inspected by a DFS (Data Flow Systems, Inc.) certified technician, on-site warranty services are provided for one (1) year covering defects in installation, material and workmanship. The one year on-site installation warranty also includes 24/7 factory phone support. On-site warranty services must be initiated by contacting our Service Department via telephone at 321-259-5009.

PHONE SUPPORT

Factory phone support will be supplied during normal business hours, for the life of the product. Normal business hours are weekdays, excluding holidays, 8:00 AM to 5:00 PM Eastern Time Zone. Factory phone support outside of normal business hours, weekends and holidays will be charged against the current hourly rate. A one-hour minimum charge will apply. A dial-up phone line must be connected to the Hyper SCADA Server (if applicable) to receive full support. Contact our Service Department via telephone at 321-259-5009.

QUESTIONS OR COMMENTS ON THIS MANUAL

If you find a problem with any of the information in this manual or have suggestions on how it could be improved, please contact us at the address below:

If you find a problem with any of the information in this manual or have suggestions on how it could be improved, please contact us at the address below:

Open Control Solutions
Documentation Department
605 N. John Rodes Blvd.
Melbourne, FL 32934

Alternatively, e-mail us at:

sales@opencontrolsolutions.com

- alarm call
 - receiving and acknowledging, 37
- alarm LED, 6
- analog input
 - bit format, 31
 - connector pins, 11
 - specifications, 4
 - using as digital I/O, 31
 - wiring, 31
 - wiring 1-5V/0-5V voltage source, 33
 - wiring 4-20mA/0-20mA current loop, 32
- autodialer
 - compatible phone systems, 36
 - connect RDP180 to a phone line, 36
 - description of alarm dial out process, 36
 - operations overview, 19, 35
 - receiving and acknowledging an alarm call, 37
- battery
 - recommended optional backup, 48
 - wiring optional backup, 24
- Battery
 - Specifications for optional backup, 24
- battery voltage
 - affect on ladder, 43
- cables
 - how to connect and disconnect, 13
- COM1
 - Connector pins for RS-232 interface, 10
 - connector pins for RS-485 interface, 11
 - operations overview, 16
 - specifications for RS-232 interface, 5
 - specifications for RS-485 interface, 5
- COM2
 - Connector pins, 11
 - operations overview, 16
 - specifications for, 5
 - wiring, 26
- communication problems
 - troubleshooting, 39
- connector pins. *See* pins
- connectors
 - how to connect and disconnect, 13
- custom screens, 18
- description of RDP180, 3
- dial out process for alarms
 - description, 36
- digital inputs
 - connector pins, 11
 - specifications, 4
 - wiring, 29
- digital outputs
 - connector pins, 11
 - specifications, 4
 - wiring, 30
- dimensions of RDP180, 7
- DIN-rail
 - acceptable models of, 23
 - mounting the RDP180 on a, 23
- electrostatic discharge
 - protecting against, 14
- equipment
 - receiving, 14
- Ethernet interface
 - connect RDP180 to network via, 24
 - operations overview, 16
 - recommended network surge arrester, 48
 - recommended serial-to-network protocol converter, 48
 - specifications, 6
 - use of surge arrester with, 24
- factory default state
 - reset RDP180 to, 42
- fault LED, 6
- features
 - common
 - of RDP180, 3
 - of RDP180-1, 3
 - of RDP180-2, 3
- firmware, updating, 45
- getting started, 21
- hook LED, 7
- humidity
 - safe operating range, 4
- I/O mapping, 17
- installing the RDP180
 - analog input, wiring of, 31
 - COM1 interface, wiring of, 25
 - COM2 interface, wiring of, 26
 - digital inputs, wiring of, 29
 - digital outputs, wiring of, 30
 - Ethernet interface, 24
 - mounting on a DIN-rail, 23
 - protecting against electrostatic discharge, 14

Index

- safety precautions to observe, 13
- serial cable wiring options, 27–28
- serial interfaces, wiring of, 25
- site selection, 14
- interface
 - description of RDP180, 8
- IP address
 - determining, 41
- ladder logic, 17
 - using to shut down ladder, 44
- ladder shut down
 - due to Low battery voltage, 43
 - using logic and special function registers, 44
 - using shut down button, 43
- ladder shut down procedure, 43
- LEDs
 - alarm, 6
 - fault, 6
 - hook, 7
 - link, 7
 - power, 6
 - RX1, 6
 - RX2, 6
 - RXD, 6
 - status, 6
 - TX1, 6
 - TX2, 6
 - TXD, 7
- link LED, 7
- mapping I/O, 17
- modem specifications, 6
- network. *See* Ethernet interface
- network surge arrester
 - recommended, 48
- onboard I/O
 - connector pins, 11
 - operations overview, 16
- operations overview, 15
- parts
 - furnished, 47
 - optional, 47
- phone line
 - connect RDP180 to, 36
- pins
 - for analog input, 11
 - for COM1 (RS-232), 10
 - for COM1 (RS-485), 11
 - for COM2, 11
 - for digital inputs, 11
 - for digital outputs, 11
 - for onboard I/O, 11
 - for power, 10
- power
 - connector pins, 10
 - requirements, 24
 - specifications, 4
 - wiring, 24
- power LED, 6
- power supply
 - recommended, 48
- principles of operation, 15
 - autodialer, 19
 - COM1, 16
 - COM2, 16
 - controlled shutdown, 18
 - Ethernet interface, 16
 - I/O mapping, 17
 - monitoring and controlling with custom screens, 18
 - onboard I/O, 16
 - programmed with ladder logic, 17
 - serial ports, 16
 - voltage monitoring, 18
- protocol converter. *See* serial-to-network protocol converter
- quick start guide, 21
- radio
 - recommended, 48
- RDP180
 - description, 3
 - dimensions, 7
 - features, 3
 - recommended network surge arrester, 48
 - recommended optional backup battery, 48
 - recommended power supply, 48
 - recommended radio, 48
 - technical specifications, 4
- receipt of equipment, 14
- registers
 - special function, 9
- release notes, 49–50
- reset RDP180 to factory default state, 42
- RX1 LED, 6
- RX2 LED, 6
- RXD LED, 6
- safety
 - general precautions, 13
 - protecting against electrostatic discharge, 14
- serial interfaces
 - specifications, 5
- serial ports
 - COM1 overview, 16
 - COM1 wiring, 25
 - COM2 overview, 16
 - COM2 wiring, 26

- operations overview, *16*
- wiring overview, *25*
- serial-to-network protocol converter
 - recommended, *48*
- service
 - obtaining, *51*
- shutdown button
 - use to stop and start ladder, *43*
- shutdown, controlled, *18, 43*
- site selection, *14*
- special function registers, *9*
 - using to shut down ladder, *44*
- specifications
 - for analog input, *4*
 - for COM1 (RS-232), *5*
 - for COM1 (RS-485), *5*
 - for COM2, *5*
 - for digital inputs, *4*
 - for digital outputs, *4*
 - for Ethernet interface, *6*
 - for modem, *6*
 - for onboard I/O, *4*
 - general, *4*
- status LED, *6*
- support
 - obtaining, *51*
- surge arrester. *See* network surge arrester

- system
 - process for designing, *21*
- temperature
 - safe operating range, *4*
- troubleshooting communication problems, *39*
- TX1 LED, *6*
- TX2 LED, *6*
- TXD LED, *7*
- update firmware, *45*
- voltage monitoring, *18*
 - controlled shutdown, *18*
- warranty information, *53*
- wiring
 - analog input, *31*
 - COM1, *25*
 - COM2, *26*
 - digital inputs, *29*
 - digital outputs, *30*
 - Ethernet interface, *24*
 - power, *24*
 - serial cable options, *27–28*
 - serial interfaces, *25*



Open Control Solutions, Inc.

605 N. John Rodes Blvd.

Melbourne, FL 32934

321-435-5010

www.openconrolsolutions.com